

Force 2

*Electrosurgical
Generator*

***Instruction
Manual***



FORCE 2

Instruction Manual

Equipment covered in this manual: F2-20 PC MIL
Electrosurgical Apparatus
115/220 VAC Nominal, 50/60 Hz
National Stock Number (NSN): 6515-01-309-6647

Valleylab, Inc.
5920 Longbow Drive
Boulder, Colorado 80301 USA

1-303-530-2300 / TWX 910-940-2514

FOREWORD

This manual and the equipment it describes are for use only by qualified medical professionals trained in the particular technique and surgical procedure to be performed.

Follow the instructions in this manual for proper use of the Electrosurgical Apparatus. Do not tamper with any components, or modify the configuration of any item supplied with the Electrosurgical Apparatus.

CAUTION: Federal (USA) law restricts this device to sale by or on the order of a physician.

Valleylab, its dealers and representatives reserve the right to make changes in equipment built and/or sold by them at any time without incurring any obligation to make the same or similar changes on equipment previously built and/or sold by them.

Effective Date: February, 1990

Valleylab Part No.: 945 110 052 A

The Electrosurgical Apparatus is capable of utilizing 115VAC (nominal) or 220VAC (nominal) line input voltage.

NOTE: THE ELECTROSURGICAL APPARATUS IS CONFIGURED BY VALLEYLAB WITH THE INPUT POWER SOURCE SWITCH IN THE 115VAC POSITION AND WITH THE PROPER 115VAC HOSPITAL GRADE POWER CORD.

UTILIZATION OF THE 220VAC (NOMINAL) INPUT LINE VOLTAGE REQUIRES THAT THE INPUT POWER SOURCE SWITCH BE IN THE 220VAC POSITION AND THAT THE PROPER 220VAC HOSPITAL GRADE POWER CORD BE INSTALLED ON THE ELECTROSURGICAL APPARATUS.

Contact a Valleylab Service Center for assistance in configuring the power cord for your application.

Copyright © Valleylab, Inc., 1990

All rights reserved. Contents of this publication may not be reproduced in any form without the written permission of Valleylab, Inc.

Table of Contents

GENERAL DESCRIPTION OF THE CLINICAL USE . . .	1
ELECTROSURGICAL WARNINGS AND PRECAUTIONS	2
GENERAL PRECAUTIONS	2
ELECTROSURGICAL GENERATOR	3
ACTIVE ACCESSORIES, DISPOSABLES, PATIENT RETURN ELECTRODES	4
CLEANING INSTRUCTIONS	5
PACKAGING	6
DESCRIPTION	6
COMPONENTS	6
UNPACKING INSTRUCTIONS	6
PACKING INSTRUCTIONS	6
EQUIPMENT ITEMS	9
DESCRIPTION OF CONTROLS, INDICATORS, AND RECEPTACLES	10
CONTROLS	12
INDICATORS	13
ALERTS	14
RECEPTACLES	15
REAR PANEL FUNCTIONS	16
SET UP INSTRUCTIONS FOR GENERAL USE	18
POWER-UP SELF TEST	18
SELECTING MODES AND POWER LEVELS	20
PATIENT RETURN ELECTRODE APPLICATION	20
TYPICAL POWER SETTINGS FOR VARIOUS SURGICAL PROCEDURES	20
POWER OFF	21
ACCESSORY CONNECTIONS TO THE GENERATOR	21
POWER CHANGES	26
RECOMMENDATIONS DURING SURGERY	27
LOW VOLTAGE COAG	27
OPERATING ROOM TROUBLESHOOTING	28
PROBLEM – REM™ ALARM	28
PROBLEM – NO OUTPUT	30
PROBLEM – MONITOR INTERFERENCE	30
PROBLEM – NEUROMUSCULAR STIMULATION	31
PROBLEM – PACEMAKER INTERFERENCE	31

GENERAL ELECTROSURGERY	32
KEYING/ACTIVATION SYSTEMS	32
FOOTSWITCHES	32
HANDSWITCHING FORCEPS AND PENCILS	32
USE OF MULTIPLE ACTIVE ELECTRODES	32
PATIENT RETURN ELECTRODES	34
REM™ POLYHESIVE®II PATIENT RETURN ELECTRODE	34
CONVENTIONAL, SINGLE-SECTION PATIENT RETURN ELECTRODES	35
THE REM™ CONTACT QUALITY MONITORING SYSTEM	36
TECHNICAL SPECIFICATIONS	38
OUTPUT WAVEFORM	38
OUTPUT CHARACTERISTICS	38
LOW FREQUENCY LEAKAGE (50/60 HZ)	38
HIGH FREQUENCY RISK PARAMETERS	38
REM™ CONTACT QUALITY MONITOR	39
INPUT POWER SOURCE	39
POWER CORD LENGTH	39
AUDIO VOLUME	39
DISPLAYS/CONTROLS	39
WEIGHT	39
SIZE	39
GLOSSARY	44
LIMITED WARRANTY	46
APPENDIX	A-1

List of Figures

FIG. 1	PACKING CONFIGURATION	7
FIG. 2	GENERATOR/CART ASSEMBLY	8
FIG. 3	ACCESSORIES PACKING	8
FIG. 4	FRONT VIEW	10
FIG. 5	REAR VIEW	11
FIG. 6	GENERATOR SELF-TEST MODE	18
FIG. 7	GENERATOR STANDBY MODE	19
FIG. 8	GENERATOR READY MODE	19
FIG. 9	BIPOLAR HANDSWITCHING FORCEPS	21
FIG. 10	HANDSWITCHING PENCIL	22
FIG. 11	SIMULTANEOUS COAG WITH HANDSWITCHING PENCILS	22
FIG. 12	HANDSWITCHING PENCIL AND BIPOLAR FORCEPS	23
FIG. 13	FOOTSWITCHING SURGICAL HANDLE	23
FIG. 14	BIPOLAR FOOTSWITCH CONNECTION	24
FIG. 15	MONOPOLAR FOOTSWITCH CONNECTION ..	24
FIG. 16	HANDSWITCHING PENCIL AND FOOTSWITCHING SURGICAL HANDLE (ELECTRODES NOT SHOWN)	25
FIG. 17	SILENCING THE REM™ ALARM	29
FIG. 18	REM™ SYSTEM SCHEMATIC	37
FIG. 19	TYPICAL OUTPUT POWER VS LOAD – MONOPOLAR CUT MODES	40
FIG. 20	TYPICAL OUTPUT POWER VS LOAD – COAG MODES	42
FIG. 21	TYPICAL OUTPUT POWER VS LOAD – BIPOLAR	43

GENERAL DESCRIPTION OF THE CLINICAL USE

Scope

This manual is intended as a user's guide only. For complete technical specifications and descriptions of the Force 2 generator, refer to the Service Manual.

Introduction

The Force 2 Electrosurgical Generator described in this manual is designed to provide the three most significant electrosurgical effects: cutting, desiccation, and fulguration. Solid state design provides both Monopolar and Bipolar outputs.

The Monopolar outputs are designed with the capability of delivering smooth cutting, cutting with increasing degrees of hemostasis, and fulguration with a minimum of cutting. The Bipolar output is intended for desiccation without fulguration.

ELECTROSURGICAL WARNINGS AND PRECAUTIONS

The safe and effective use of electrosurgery is dependent, to a large degree, upon factors solely under the control of the operator. There is no substitute for a properly trained and vigilant operating room staff. It is important that the operating instructions supplied with this or any electrosurgical equipment be read, understood and followed.

GENERAL PRECAUTIONS

Electrosurgery has safely been employed in numerous procedures. Nevertheless, special precautions may be required based on the presence of external or internal pacemakers, or monitoring equipment, or the patient's condition, including age, and size of the appendage or organ to be operated on. While physicians have successfully employed electrosurgery in performing circumcisions, Valleylab believes that the associated risks outweigh the benefits, particularly because other traditional, effective techniques are available. Accordingly, Valleylab recommends against the use of Monopolar or Bipolar electrosurgery for circumcisions. Before commencing any surgical procedure, the physician should be familiar with the medical literature on the use, complications, and hazards of electrosurgery in that procedure.

WARNING: Electrosurgery uses radio-frequency energy to cut and coagulate tissue. The sparking and heat associated with electrosurgery can provide an ignition source. Electrosurgery is inherently unsafe for use with flammable anesthetics or other flammable gases, near flammable fluids or objects, or with oxidizing agents. Observe appropriate fire precautions at all times when using electrosurgery. Restrict flammable materials including flammable gases, and oxidizing agents from the electrosurgical site.

- Do not use electrosurgery in the presence of flammable anesthetics or other flammable gases, flammable liquids, or flammable objects.
- Do not use electrosurgery in oxygen enriched atmospheres, nitrous oxide (N₂O) atmospheres, or in the presence of other oxidizing agents.
- Prevent accumulation of oxygen, other oxidizing gases such as nitrous oxide (N₂O), and flammable gases, under surgical drapes, or within the area where electrosurgery is performed.
- Verify that all oxygen circuit connections are leak-free before and during the use of electrosurgery. Verify that endotracheal tubes are leak-free, and that the cuff is properly sealed to prevent oxygen leaks.
- Do not use electrosurgery in the presence of naturally occurring flammable gases which may accumulate in body cavities such as the bowel.
- Do not use electrosurgery in the presence of flammable liquids (such as skin prepping agents and tinctures). Avoid pooling of flammable liquids.
- Do not place electrosurgical active accessories near, or in contact with, flammable materials (such as gauze). Electrosurgical accessories which are hot from use, or accessories which are activated, can cause a fire. The Valleylab E2400 Holster is designed to hold electrosurgical pencils and similar accessories safely away from patients, personnel, and surgical drapes.

Electrosurgical generators should be used with caution in the presence of internal or external pacemakers. Interference from the electrosurgical current can cause a pacemaker to enter an asynchronous mode or can block the pacemaker effect entirely. When questions arise, consult the pacemaker manufacturer and/or the cardiology department.

While using electrosurgery during a surgical procedure, the patient should not be allowed to come into direct contact with grounded metal objects (surgical table frame, instrument table, etc.). This may not be practical during certain procedures (e.g. those in which non-insulated head frames are used). Use extreme caution in those situations, to maximize patient safety.

Electrodes and probes found on monitoring, stimulation and imaging devices or similar equipment, can provide a path for high frequency current, even if those electrodes and/or probes are isolated at 60 Hz, insulated, and/or battery operated. The risk of an electrosurgical burn can be reduced but not eliminated by placing the electrodes or probes as far as possible from the electrosurgical site and the patient return electrode (also referred to as "patient pad" or "patient plate"). Protective impedances (resistors or RF inductors) installed in the monitoring leads may reduce the risk of such burns. The hospital biomedical engineer should be consulted for further information. Needles should not be used as monitoring electrodes during electrosurgical procedures.

When an electrosurgical unit is activated, the conducted and radiated electrical field may interfere with other electronic medical equipment (such as monitors). Provide as much distance as possible between the monitor and the electrosurgical generator to minimize interference paths.

Skin-to-skin contact (for example, between the arms and the trunk of the patient) should be avoided by the placement of two to three inches of dry gauze. This will reduce the potential for alternate site burns.

ELECTROSURGICAL GENERATOR

DANGER: Explosion hazard. Do not use in the presence of flammable anesthetics.

WARNING: Hazardous electrical output. This equipment is for use only by qualified personnel.

WARNING: Use of a conventional, non-REM™ patient return electrode will not activate the REM™ contact quality monitoring system.

WARNING: The activation tone is an important safety feature. DO NOT turn down to an inaudible level.

CAUTION: This equipment has an output which is capable of causing a physiological effect.

CAUTION: Electrical shock hazard. Do not remove cover. Refer to authorized personnel for service.

CAUTION: DO NOT connect more than one device to the ACCESSORY output. Both output jacks (3-pin and 1-pin) of the ACCESSORY output will activate simultaneously.

DANGER: HIGH VOLTAGE. Change fuses only when input power is off. Refer to trained personnel for service.

Never increase the power settings without first checking both the active and the patient return electrodes and their connections. In general, the active electrode should be utilized only for the minimum time necessary to achieve the desired surgical effect in order to minimize the possibility of unintended burns. This is especially true in pediatric and neonatal applications and where small appendages are involved.

Failure of the electrosurgical equipment to produce the desired effect at otherwise normal power settings may indicate faulty application of the patient return electrode or failure of an electrical lead. Do not increase power output settings before checking for problems with accessory leads or misapplication of the return electrode. Effective contact between the patient and return electrode must be verified if the patient is repositioned after the initial application of the return electrode.

Potentially hazardous conditions may exist when electrosurgical accessories with similar connector types are used interchangeably. Be certain that Monopolar and Bipolar accessories are used in the appropriate power output receptacles.

The electrical cord of the generator should be connected to a properly grounded receptacle. Extension cords and/or adapter plugs should not be used.

Random electronic component failures may occur, leading to unintentional or increased output or non-function of the generator. A back-up generator should be available.

Refer to the Service Manual for preventative maintenance recommendations, function, and output power verification procedures. Refer servicing to qualified personnel, or contact Valleylab.

ACTIVE ACCESSORIES, DISPOSABLES, PATIENT RETURN ELECTRODES

Read the instructions, cautions and warnings provided with electrosurgical accessories before using.

WARNING: Keep active accessories away from the patient when not in use.

CAUTION: Accessories must be connected to the proper receptacle type. In particular, Bipolar accessories must be connected to the MICROBIPOLAR receptacle only. Improper connection of accessories may result in inadvertent generator activation or a REM™ alarm.

CAUTION: Accessories labeled as “disposable” are single use only. Do not reuse or resterilize.

Special precautions should be taken when utilizing electrosurgery in close proximity to or in direct contact with any metal objects including, but not limited to, Gomco clamps, Kocher clamps, and hemostats. Such electrosurgical usage, particularly over prolonged periods of time, could result in unintentional and unwanted tissue destruction and burns.

CAUTION: Some surgeons may elect to “buzz the hemostat” during surgical procedures. The hazards of such a procedure probably cannot be reduced entirely, and burns to the surgeon’s hands are possible.

Suction Coagulators

WARNING: Care should be taken to insure that the outside of the coagulator suction tube remains free of blood and mucus. Failure to clean the coagulator suction tube can allow electrical conductance by means of the contaminants, which may result in unintended burns.

CAUTION: To avoid the possibility of a burn to the surgeon, always place the generator in the Standby mode prior to bending or reshaping the coagulator suction tube.

Do not immerse in conductive fluids.

Patient Return Electrodes

A critical element in the safe use of Monopolar electrosurgery is the proper placement of the patient return electrode. To avoid radio frequency burns beneath the patient return electrode, follow all directions for the placement, use, and removal of the return electrode, as supplied on the product package.

To enhance patient safety, monitor the patient return electrode to assure firm contact with the skin. This is especially important during procedures involving long periods of “keying”. Monitoring the patient return electrode for firm skin contact can reduce REM™ alarms.

Valleylab recommends the use of REM™ dual-section patient return electrodes to maximize patient safety.

WARNING: Never cut the patient return electrode to reduce size.

DO NOT apply a patient return electrode for a Bipolar-only procedure.

CLEANING INSTRUCTIONS

Use a mild detergent and damp cloth to clean the generator cover, keyboards and cord. The generator is not sterilizable. Do not allow fluids to enter the chassis.

See APPENDIX for cleaning instructions of accessories.

PACKAGING

DESCRIPTION

The Force 2 Electrosurgical Apparatus is made up of several different components. The components of the kit are packaged into intermediate and unit containers. The containers are assembled and packed into an exterior box to form a single unit.

COMPONENTS

The components of the kit are categorized into major groups to aid personnel in re-packing:

- Electrosurgical Generator
- Mobile Cart
- Footswitches
- Electrosurgical Accessories

UNPACKING INSTRUCTIONS

Refer to Fig. 1 for container designators.

Refer to the Basic Packaging list in the Section EQUIPMENT ITEMS for item numbers of the kit components.

- a) Open the exterior shipping container (A) from the top and remove the individually packed containers.
- b) Pull the generator cart (item 2) and the generator (item 1) from the unit containers (C and B).
- c) Assemble the generator cart by installing the four casters to the bottom plate. Slots are provided on each corner for the casters. Install the generator on the cart (Fig. 2). (Refer to the Appendix of this manual for complete assembly and mounting instructions.)
- d) Remove accessory items from intermediate and unit containers as required. Space is provided in the cart for many of the accessories to be stored.

PACKING INSTRUCTIONS

- a) Remove all loose kit items from the generator cart and pack into the intermediate containers (Fig. 3).
- b) Place all unit items into their designated containers and re-tape the flaps.
- c) Place all unit containers and intermediate packs into the exterior pack. Refer to Fig. 1 for the loading configuration of the individual boxes into the exterior shipping container.

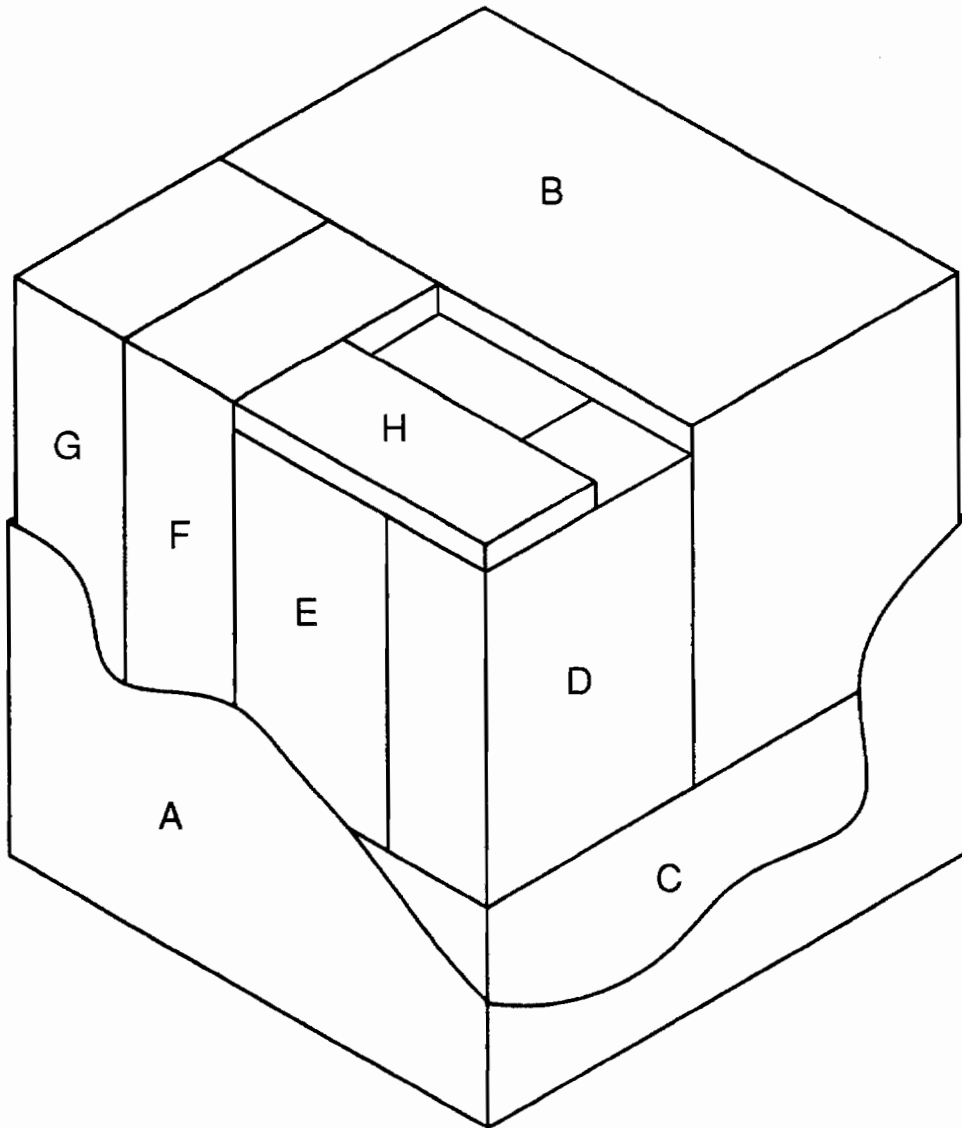

CONTAINER DESIGNATOR	ITEM	DESCRIPTION	PACK TYPE
A	COMPLETE KIT	F2-20 PC MIL ELECTROSURGICAL APPARATUS	EXTERIOR
B	1	ELECTROSURGICAL GENERATOR	UNIT
C	2	MOBILE CART	UNIT
D	8,9,10,11,12,13,16,17	ACCESSORIES	INTERMEDIATE
E	5,7,14,15	ACCESSORIES	INTERMEDIATE
F	3	MONOPOLAR FOOTSWITCH	UNIT
G	4	BIPOLAR FOOTSWITCH	UNIT
H	6	PATIENT PLATE ELECTRODE	UNIT

Fig. 1 Packing Configuration

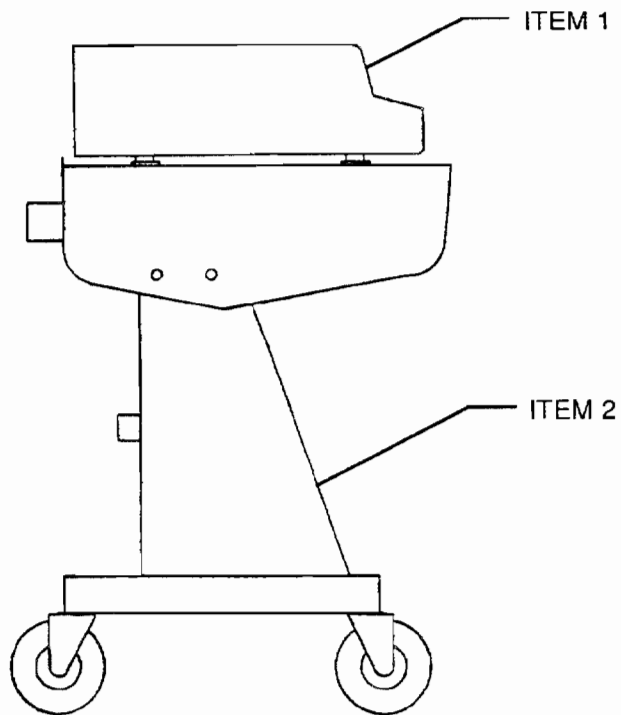

Fig. 2 Generator/Cart Assembly

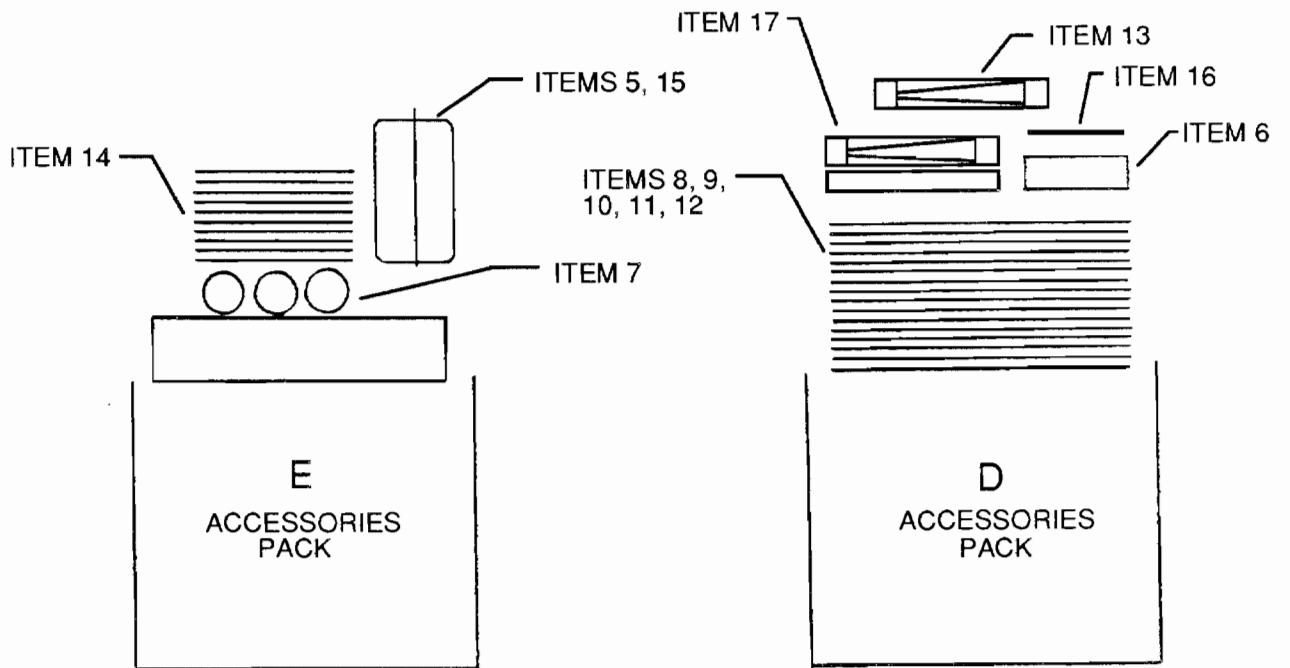

Fig. 3 Accessories Packing

EQUIPMENT ITEMS

The basic packaging of the F2-20 PC MIL Electrosurgical Apparatus Kit includes:

ITEM NO.	QTY	DESCRIPTION	VALLEYLAB CATALOG #
1	1 EACH	ELECTROSURGICAL GENERATOR	F2-20 PC MIL
	2 EACH	INSTRUCTION MANUAL	945 110 052
	2 EACH	SERVICE MANUAL	945 100 117
2	1 EACH	MOBILE CART	E8006
3	1 EACH	MONOPOLAR FOOTSWITCH	E6008
4	1 EACH	BIPOLAR FOOTSWITCH	E6009
5	1 EACH	REUSABLE HANDSWITCHING PENCIL	E2502B
6	1 EACH	PATIENT PLATE ELECTRODE (PERMANENT PATIENT PLATE) WITH DUAL LEAD	E7001-1R PLATE E0009-1R CORD
7	13 EACH	8 OZ. TUBE CONDUCTIVE GEL	E5501
8	1 EACH	ELECTRODE, 7/32" COAGULATION BALL	E1002
9	1 EACH	ELECTRODE, 3/4" NEEDLE	E1003
10	16 EACH	ELECTRODE, 1" STRAIGHT SKIN INCISION BLADE	E1001
11	1 EACH	ELECTRODE, 3/32" ANGLED COAGULATION BALL	E1004
12	1 EACH	ELECTRODE, 3/8" CUTTING AND BIOPSY LOOP	E1005
13	1 EACH	FORCEPS 4-3/4" STRAIGHT TIP, PERMANENT, HANDSWITCHING	E4086
14	12 EACH	DISPOSABLE DISPERSIVE ELECTRODE (PATIENT RETURN ELECTRODE)	E7506
15	1 EACH	DISPOSABLE SWITCHING HANDLE PRE-STERILIZED	E2515
16	1 EACH	SURGICAL HANDLE AND CORD	E2003
17	1 EACH	FORCEPS 7" STRAIGHT TIP HANDSWITCHING INCLUDING HANDSWITCHING BIPOLAR CORD	E4087 E0018

See APPENDIX for cleaning and operating instructions of electrosurgical accessories.

DESCRIPTION OF CONTROLS, INDICATORS, AND RECEPTACLES

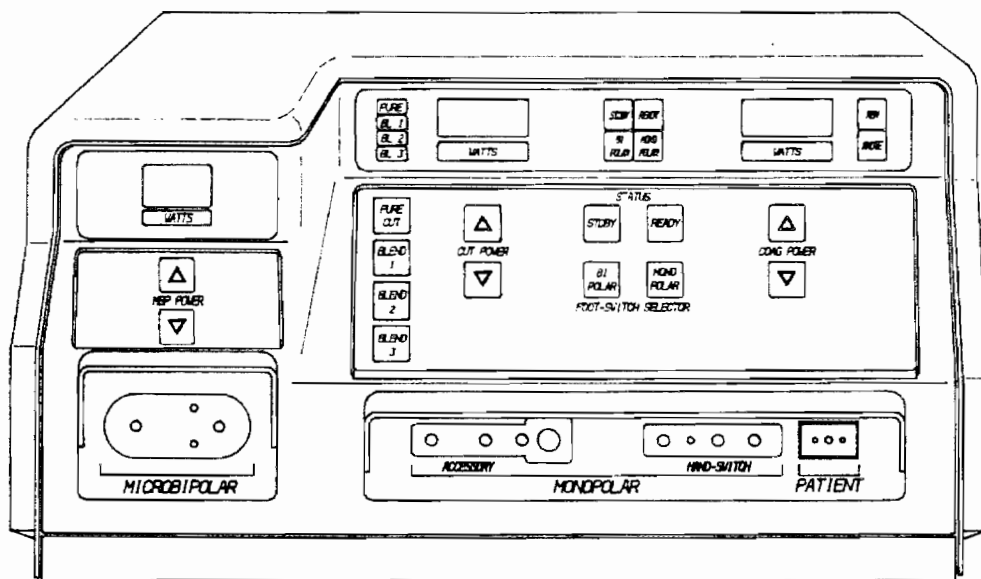

Fig. 4 Front View

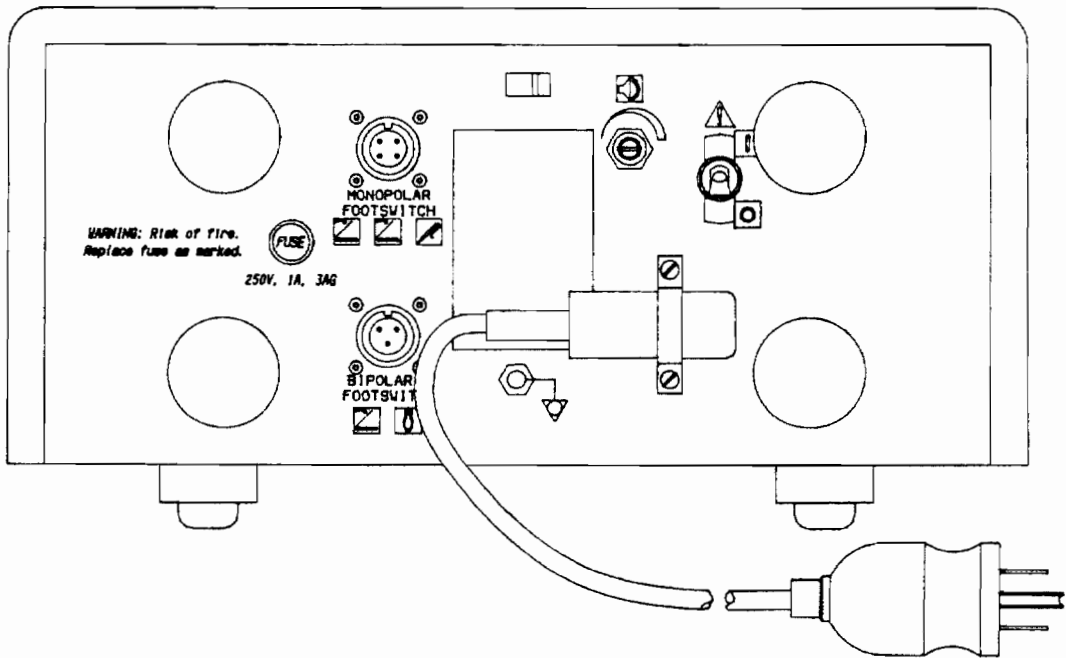

Fig. 5 Rear View

CONTROLS



Standby – Depressing this button places the electrosurgical generator in a hold mode. The generator cannot be activated and all audio alarms are silenced. Power settings are retained in memory and the display shows "dashes".



Ready – Depressing this button places the generator into service with power outputs, displays and alarms fully functional.



Monopolar – Selects monopolar footswitch control for activating ACCESSORY output.



Bipolar – Selects bipolar output when using the monopolar footswitch.



Up – Increases power in the selected mode. A single depression of the key increases the power setting by one watt. Continuous depression gradually increases the power to maximum.



Down – Decreases power in the selected mode. A single depression lowers the power setting by one watt. Continuous depression gradually decreases the power to minimum.



Cut – Selects pure cut with lowest level of hemostasis.

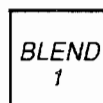

Blend 1 – Selects cut with minimum hemostasis.



Blend 2 – Selects cut with average hemostasis.



Blend 3 – Selects cut with maximum hemostasis.



CUT POWER



Power Control Pencil Mode – The Power Control Pencil feature does not have a dedicated button to access (illuminate) this mode. A two-step procedure is required. For specific instructions for activation, refer to Section titled Power Changes.



COAG POWER

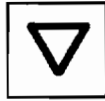

Low Voltage Coag – Low Voltage Coag does not have a dedicated button to access (illuminate) this mode. A two-step procedure is required. For a detailed explanation of the Low Voltage Coag mode, refer to Section titled Recommendations During Surgery.

INDICATORS



Standby Indicator – Indicates generator is on, but cannot activate outputs.



Ready Indicator – Indicates generator is ready for use.

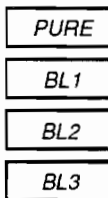

Cut Mode Indicators – One of four CUT mode indicators is illuminated to show the selected Cut mode.

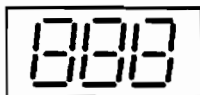

Power Setting Display – The digital power setting display is visible on the generator in the Ready mode. The number displayed indicates the nominal power, in watts, which will be delivered to the patient when the mode is activated. In Standby mode "dashes" are displayed.

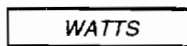

Output Power Indicators – The indicator labeled "Watts" illuminates when that output power (Cut, Coag, Bipolar) has been activated by the surgeon. One of the two distinct mode indicator tones will sound in conjunction with the visual output power indicator.



Low Voltage Coag Mode Indicator – An "L" in the hundreds digit of the Coag Power Setting Display indicates that the Low Voltage Coag mode has been selected.



Bipolar Indicator – This indicator is illuminated when the generator's Monopolar footswitch control is selected to activate the Bipolar output.



Monopolar Indicator – This indicator is illuminated when the generator's monopolar footswitch is selected for Monopolar Accessory activation.



Remote Indicator – This lamp will illuminate and the audio alarm will sound once when the remote power change feature is activated. When this indicator is illuminated, power changes can be made using the Power Control handswitching pencil.

ALERTS



REM™ Fault Indicator – This indicator illuminates when the patient contact quality monitoring system senses that contact between the patient return electrode and the patient is not adequate. The audio tone will sound twice when the condition is first detected. The generator will not produce output power when this alarm condition exists. The alarm condition is cleared when the REM™ system senses that the patient/pad contact resistance is within the acceptance range.

RECEPTACLES



PATIENT

Patient Return Electrode Receptacle – This 2-pin receptacle accepts the patient return electrode connector used in monopolar procedures. The receptacle will accept both REM™ (dual-section) and conventional patient return electrode connectors.

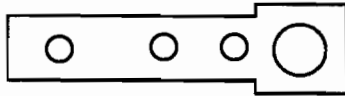

ACCESSORY

Monopolar Active Receptacle (Accessory) – This receptacle has two output jacks. It will accept 3-pin handswitching active accessories or standard 1-pin accessories which can be activated by the monopolar footswitch. Cut and Coag modes may be activated at this receptacle. The handswitching pencil can be footswitch activated when connected to this output jack. Caution: DO NOT connect more than one device to the ACCESSORY output receptacle. Both output jacks (3-pin and 1-pin) will activate simultaneously.

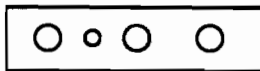

HAND-SWITCH

Monopolar Active Receptacle (Handswitch) – This receptacle will accept the 3-pin handswitching active accessories. Power output from this receptacle is activated only by using the handswitch mechanism. No power is available through use of the footswitch. Cut and Coag modes may be activated at this receptacle. Note: The Power Control pencil is only functional through this jack.

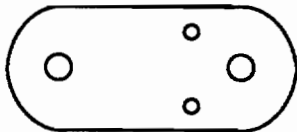

MICROBIPOLAR

Bipolar Active Receptacle – This receptacle will accept 3-pin handswitching bipolar accessories. These accessories can also be footswitch activated. This receptacle will also accept 2-pin bipolar footswitching accessories.

REAR PANEL FUNCTIONS

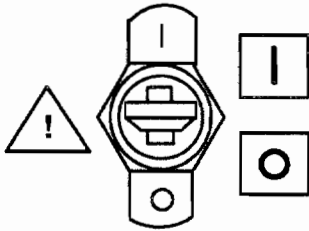

ON/OFF Switch – This switch includes a circuit breaker. Press the toggle upward to turn power on and down to shut power off.



BIPOLAR
FOOTSWITCH



Bipolar Footswitch Receptacle – This 3-pin receptacle accepts a single-treadle Bipolar footswitch connector.

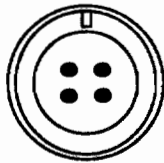

MONOPOLAR
FOOTSWITCH



Monopolar Footswitch Receptacle – This 4-pin receptacle accepts a two-treadle Monopolar footswitch connector.

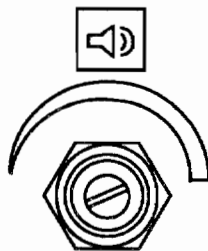

Audio Volume Control – The volume of the Cut, Coag, and Bipolar mode indicator tones produced when the generator is activated may be adjusted with this control. The volume of the audio alarm for alert conditions is not adjustable.

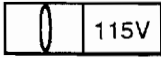
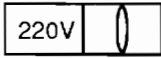

Input Power Source

Input Power Source Switch – The Force 2 will operate on both 115 volts AC power (nominal) and 220 volts AC power (nominal).

SET UP INSTRUCTIONS FOR GENERAL USE

The electrosurgical generator may be placed on the mobile cart or any sturdy table or cart. It is recommended that the cart have conductive wheels.

Provide at least four to six inches of space around the sides and top of the generator for convection cooling. Under continuous use for extended periods of time, it is normal for the top and rear panel to be warm.

The Force 2 Electrosurgical Generator is shipped with an approved Hospital Grade three terminal connector for use with 115 volt (nominal) AC power, 50/60 Hz. Check slide switch on rear panel of generator. Ensure switch is in the "115V" position before connecting the generator to AC power.

POWER-UP SELF TEST

Plug the generator into a grounded receptacle (extension cords and/or adapter plugs should not be used). Turn the power on using the ON/OFF switch which is located on the rear panel.

The generator will conduct an internal self-test during which a tone will sound, digital displays will show "8"s, and **all lamps will be on**. Insure that all digit segments, mode, alert, and power indicators light. If any of these indicators do not light, record and send generator to Biomedical engineer for service.

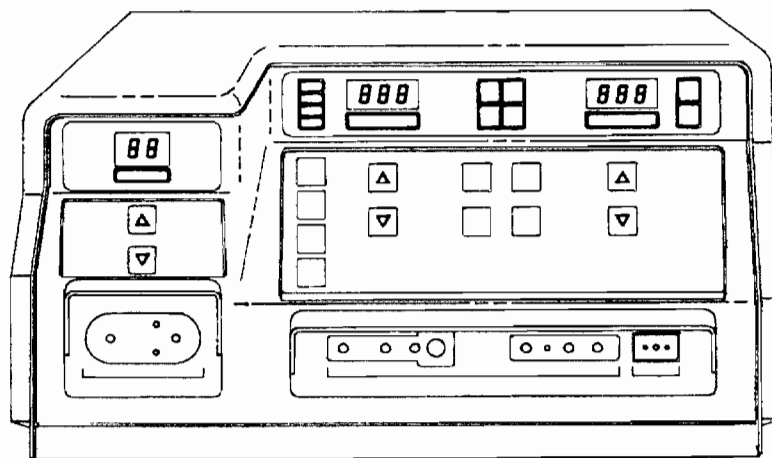

Fig. 6 Generator Self-Test Mode

In five to seven seconds, following the self-test, the generator will enter the Standby mode with the digital displays showing dashes.

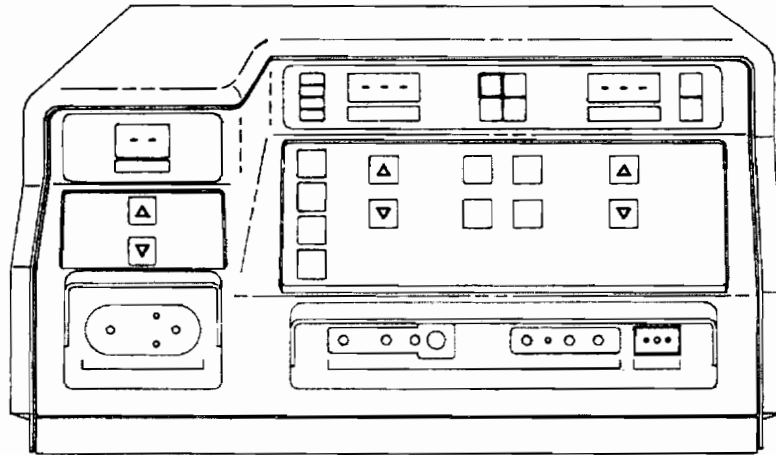

Fig. 7 Generator Standby Mode

Depress the READY button to place the generator into service. Digital displays will indicate one watt and the MONOPOLAR footswitch indicator will be illuminated.

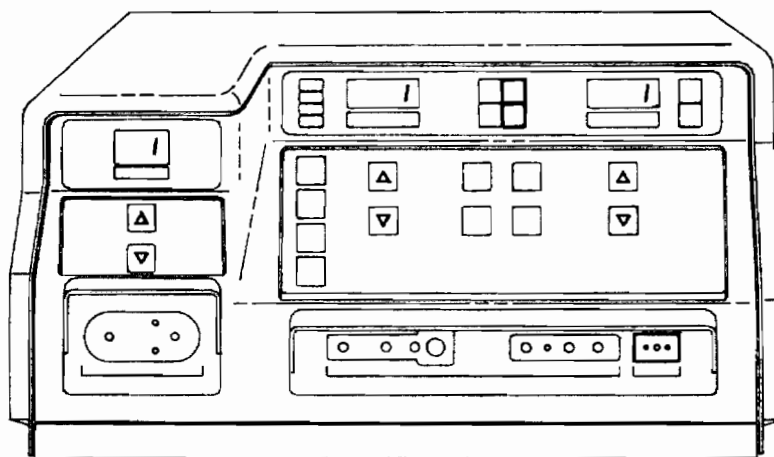

Fig. 8 Generator Ready Mode

SELECTING MODES AND POWER LEVELS FROM LEFT TO RIGHT

Set Bipolar power as desired.

Set Cut power and mode as desired.

Set Footswitch as desired.

Set Coag power as desired.

To prevent inadvertent activation, return the generator to the Standby mode until ready for use. The power setting display will show “dashes”. Note: All mode and power settings will be retained in memory and will appear on the appropriate displays when the generator is returned to the Ready mode.

While in the Standby mode, connect appropriate accessories to the generator (active accessory, footswitches, etc.). Refer to the Accessory Connections to the Generator section for illustrations of common set-ups.

PATIENT RETURN ELECTRODE APPLICATION

DO NOT apply a patient return electrode for a Bipolar only procedure.

To apply a patient return electrode to the patient, select a well vascularized, convex skin surface which is in close proximity to the surgical site. Avoid scar tissue, bony prominences, adipose tissue and areas where fluid may pool. Shave, clean, and dry the application site as needed.

For correct application and removal of the patient return electrode, follow all instructions for use found on the product packaging.

If Bipolar forceps are connected to the Bipolar output receptacle, the REM™ alarm indicator will be lit but a patient return electrode should not be connected to extinguish the alarm. The Bipolar mode can be activated with an active REM™ alarm condition.

Capacitive Pads

Valleylab does not recommend the use of capacitive patient return electrodes due to the potential of a high impedance condition at the patient/pad interface.

TYPICAL POWER SETTINGS FOR VARIOUS SURGICAL PROCEDURES

The power level used for various surgical procedures varies considerably with the surgeon's technique and the size of the active electrode. A needle electrode will require less power to sustain a spark than a large ball electrode. Moreover, one surgeon may perform a procedure by electro Surgically severing tissue with a cutting or blended waveform. Another surgeon might perform the same procedure by simply desiccating the tissue at a much lower power level.

A general outline of typical power settings:

1. Low Power – Under 30 watts
 - a) Neurosurgery (both bipolar and monopolar)
 - b) Laparoscopic sterilization (both monopolar and bipolar)
 - c) Vasectomies
 - d) Dermatology
 - e) Oral surgery
 - f) Plastic surgery

2. Medium Power – COAG 30 to 70 watts, CUT 30 to 150 watts
 - a) General surgery
 - b) Laparotomies
 - c) Head and neck surgery (ENT)
 - d) Major orthopedic surgery
 - e) Major vascular surgery
 - f) Routine thoracic surgery
 - g) Polypectomy

3. High Power – COAG over 70 watts, CUT over 150 watts
 - a) Transurethral resections (CUT 120–300 watts; COAG 50–120 watts, depending on the thickness of the resection loop and the technique of the surgeon)
 - b) horacotomies (heavy fulguration, 70 to 120 watts)
 - c) Ablative cancer surgery, mastectomies, etc. (CUT 180–300 watts; COAG 70–120 watts)

IF THE PROPER SETTING IS NOT KNOWN FROM PERSONAL EXPERIENCE, ONE SHOULD SET THE GENERATOR AT A VERY LOW SETTING AND CAUTIOUSLY INCREASE POWER UNTIL THE DESIRED EFFECT IS ACHIEVED.

POWER OFF

Depress the STDBY button to return the generator to the Standby mode. Disconnect all accessories. Turn the power off using the ON/OFF switch which is located on the rear panel.

ACCESSORY CONNECTIONS TO THE GENERATOR

WARNING: KEEP ACTIVE ACCESSORIES AWAY FROM PATIENT WHEN NOT IN USE.

Refer to the Basic Packaging list in the Section EQUIPMENT ITEMS for item numbers of accessories.

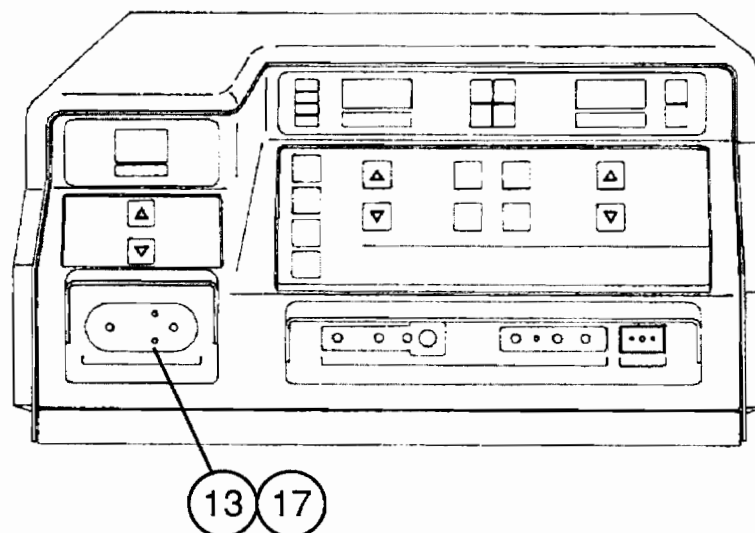

Fig. 9 Bipolar Handswitching Forceps

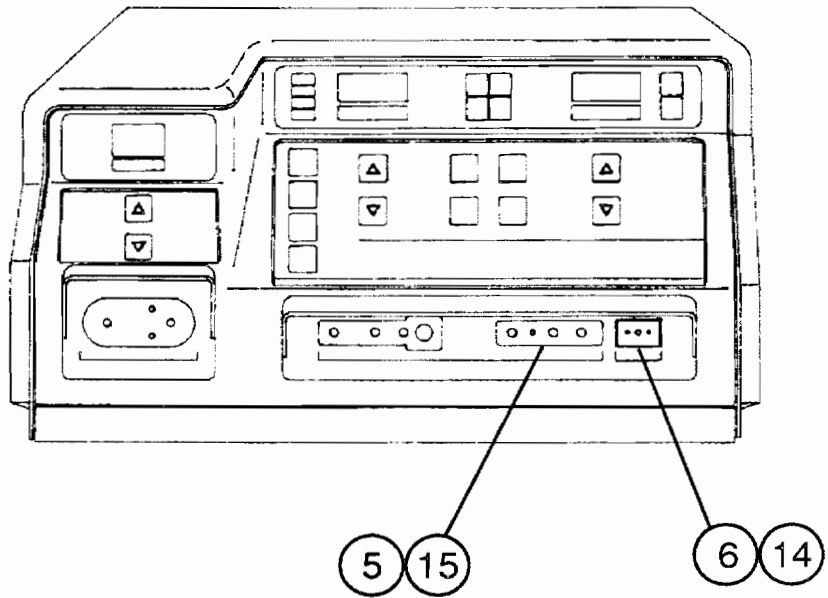

Fig. 10 Handswitching Pencil

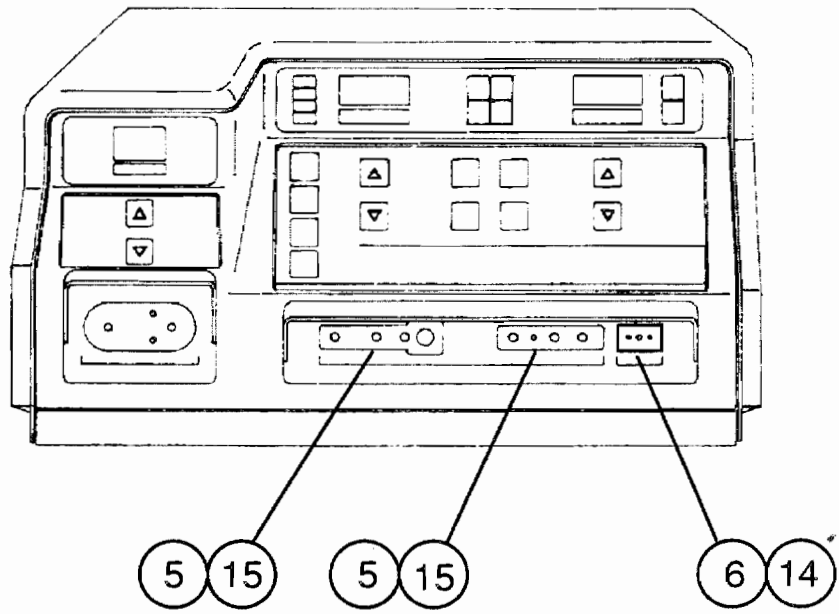

Fig. 11 Simultaneous Coag with Handswitching Pencils

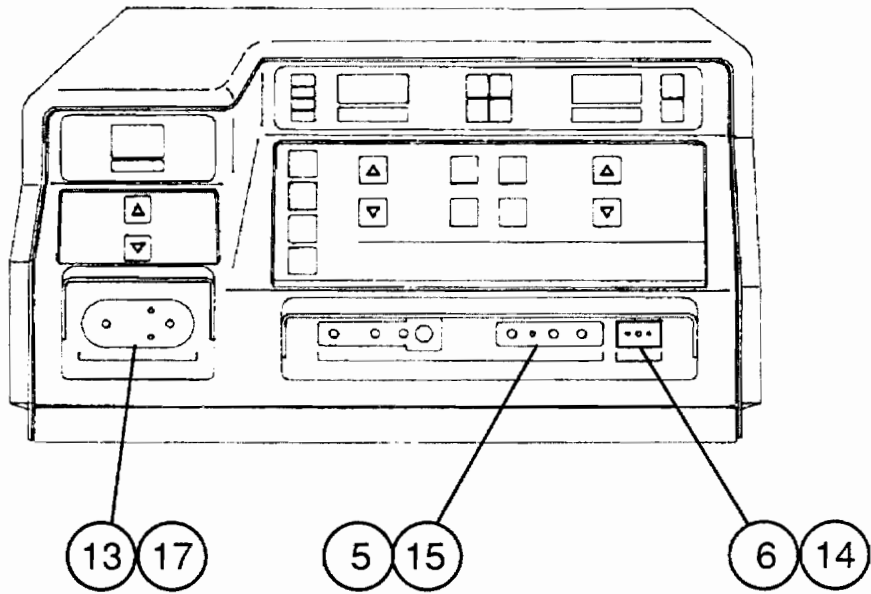

Fig. 12 Handswitching Pencil and Bipolar Forceps

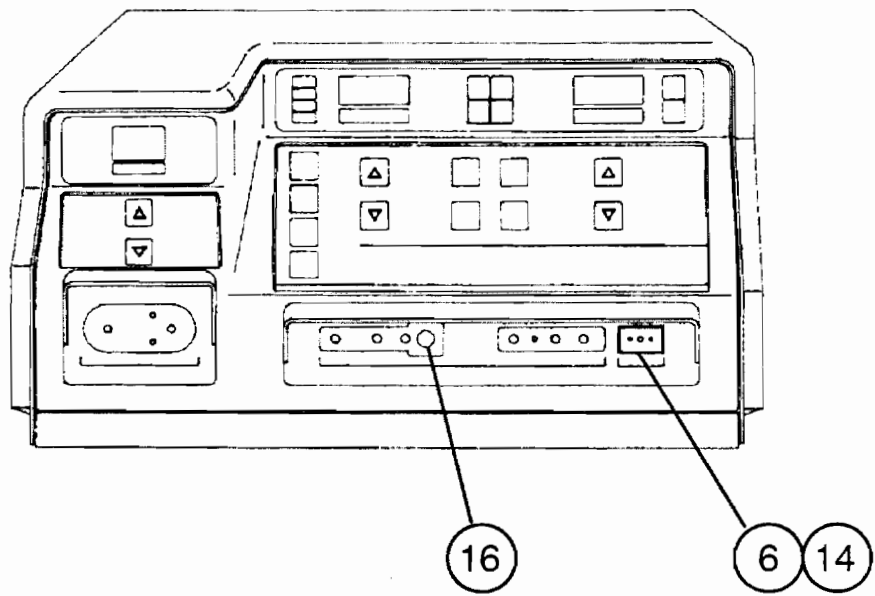

Fig. 13 Footswitching Surgical Handle

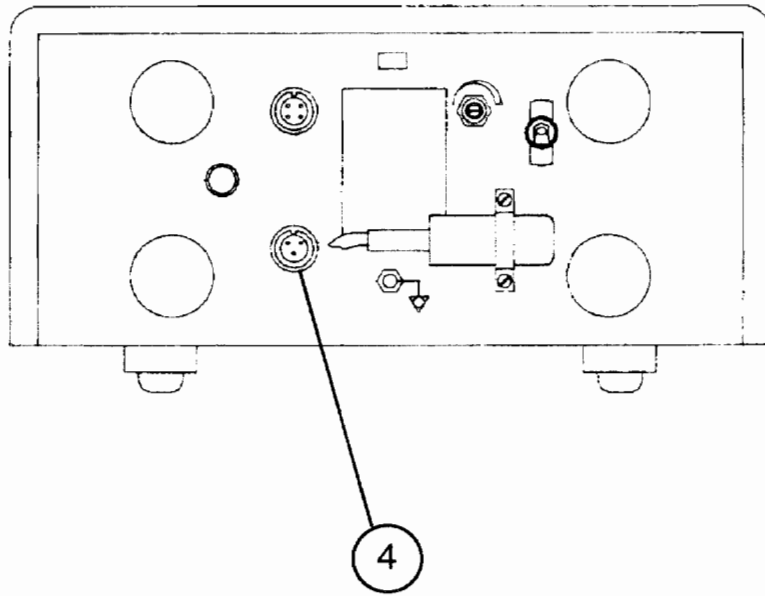

Fig. 14 Bipolar Footswitch Connection

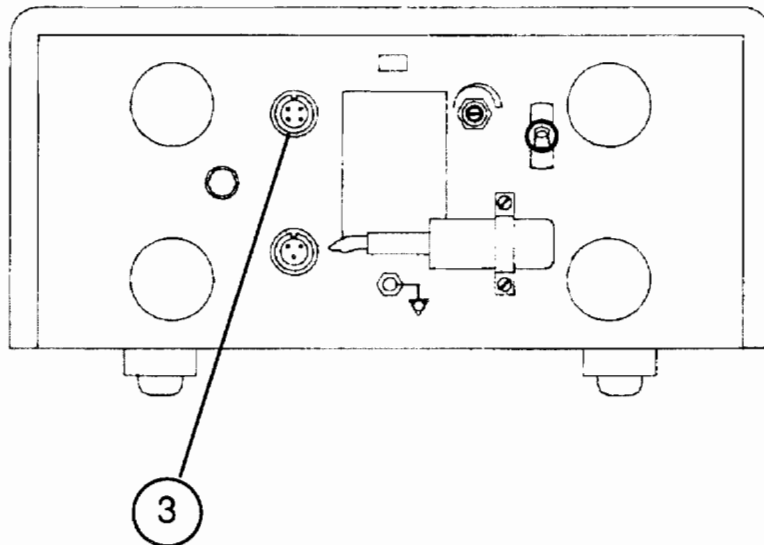

Fig. 15 Monopolar Footswitch Connection

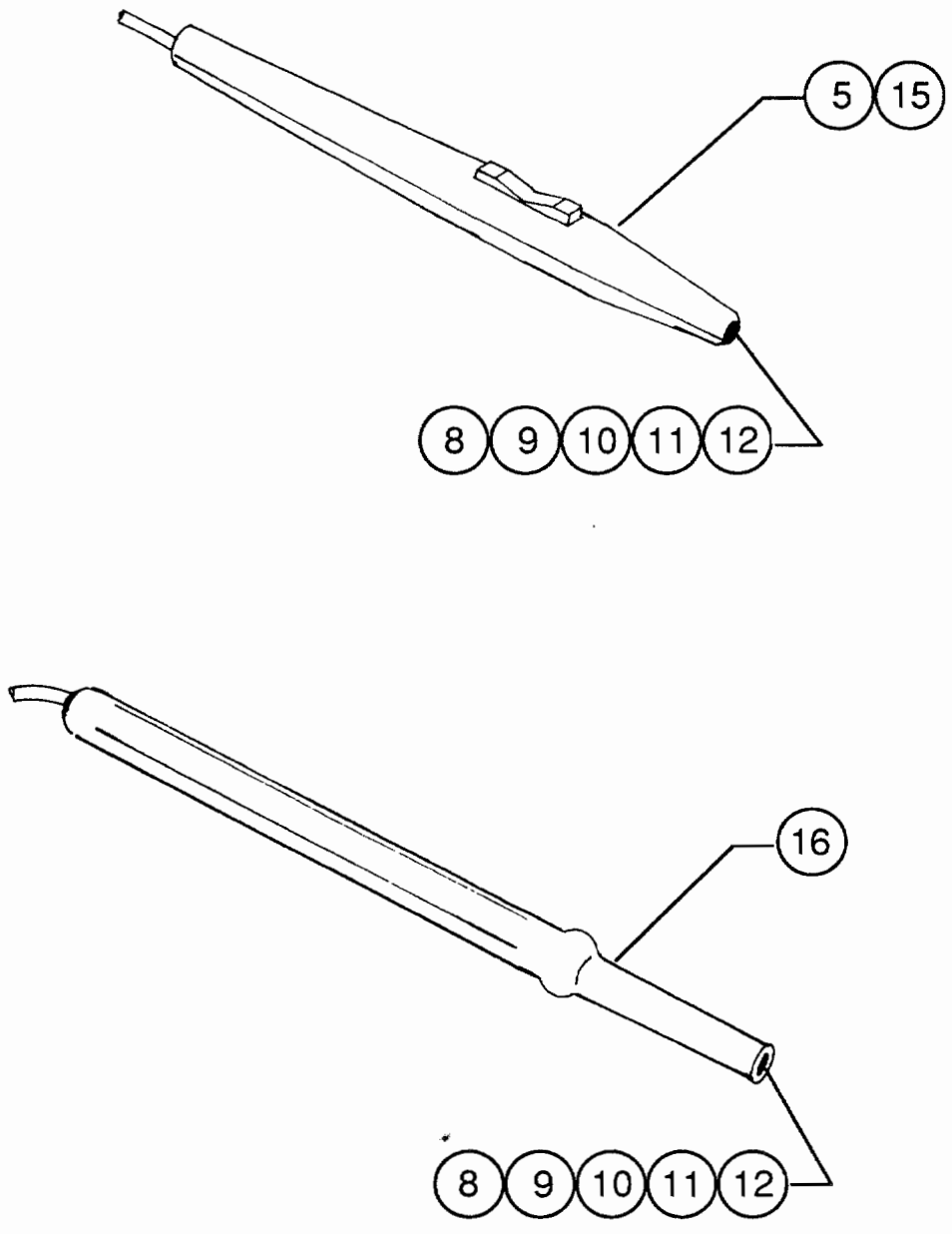

Fig. 16 Handswitching Pencil and Footswitching Surgical Handle (electrodes not shown)

POWER CHANGES

The keyboards of the Force 2 generator are disabled while an accessory is activated. This important safety feature insures that the power mode settings cannot be changed while the surgeon is cutting or coagulating. To change power settings, press the appropriate UP/DOWN power buttons (marked with triangular arrows) until the desired setting appears on the power display.

Use of the Power Control Pencil (Not supplied in the military kit)

If a Valleylab Power Control Pencil is used in the HAND–SWITCH receptacle of the Force 2 generator, the surgeon can control power settings by depressing UP/DOWN buttons located on the electrosurgical pencil upon enabling the Power Control feature.

Enable the Power Control feature by pressing the READY button, and while holding it, pressing the "CUT POWER DOWN" button on the generator front panel. The generator will respond by sounding a single tone and the RMOTE lamp will illuminate.

Increase or decrease the power of the last–used mode (Cut or Coag) by pressing the "+" or "–" pencil buttons. Generator power will increase or decrease by 12.5% or one watt, whichever is greater, of the initially set power level. If the requested power increment would cause the mode power to be less than the minimum power or greater than the maximum power, there will be no power change. Each time the power is changed a tone will sound and the new power level will be displayed on the generator. Note that the Power Control Pencil changes the power of the last mode that is activated.

The Power Control Pencil feature can be deactivated by placing the generator in STANDBY and then back to READY. Power will return to the last displayed power setting.

RECOMMENDATIONS DURING SURGERY

Refer to Electrosurgical Warnings and Precautions at the front of this manual.

Keep power settings as low as possible to enhance patient and user safety.

Remove eschar build-up from electrodes to maximize surgical effect.

Avoid unnecessary and prolonged activation of the generator to reduce the possibility of alternate site burns which may be caused by RF leakage currents.

WARNING: KEEP ACTIVE ACCESSORIES AWAY FROM THE PATIENT WHEN NOT IN USE. It is recommended that holsters be used.

If a higher than normal power setting is required, check patient return electrode and generator connecting cables for proper application and/or continuity.

When multiple accessories are used, keep lead wires separate. To reduce cross-coupling, do not twist, bundle, or clamp together.

The Force 2 generator is equipped with a REM™ contact quality monitoring circuit that operates in conjunction with a dual-section REM™ Patient Return Electrode. Any substitutions may bypass the REM™ safety feature and may result in an unintended burn.

LOW VOLTAGE COAG

The Low Voltage Coag mode is primarily designed for use with monopolar desiccation. Output power is limited to 99 watts at a reduced voltage.

The Low Voltage Coag mode is activated by pressing the READY button, and while holding it, pressing the "COAG POWER DOWN" button on the front panel. The generator will respond by displaying an "L" in the hundred's digit of the Coag power display window.

To change the Coag mode of the generator once the Low Voltage Coag mode has been activated, hold the READY button and press the "COAG POWER DOWN" button, just as the mode was activated originally. The "L" will disappear from the Coag power display to indicate that the original Coag mode has been enabled.

OPERATING ROOM TROUBLESHOOTING

PROBLEM – REM™ ALARM (2 tones)

Conventional (single–section) Patient Return Electrode (Items 6 and 14)

- a) Inspect plug, cord and pad of patient return electrode for excessive wear or visible damage. Replace if necessary.
- b) If a steel plate is used, also check that both leads are connected tightly.
- c) If REM™ alarm persists, use a back–up generator.

REM™ Patient Return Electrode (dual–section) (Not supplied in military kit)

- a) Leave the generator turned ON (READY). Unplug the patient return electrode from the PATIENT receptacle of the generator. Inspect the plug pin to insure it is not bent or missing. Carefully reinsert the plug into the PATIENT receptacle. Assure that the pin goes into the hole and that the plug on the return electrode is fully inserted into the generator receptacle. If the alarm is not cleared, continue to step B.
- b) Apply firm pressure over the entire surface area of the patient return electrode, particularly the center. If steps A and B have not cleared the REM™ alarm, turn the generator OFF (STANDBY), and unplug the patient return electrode from the generator. DO NOT remove the return electrode from the patient. Proceed to step C.
- c) Apply a second REM™ patient return electrode to an alternate site such as the upper biceps, calf or lower back. Select the forearm as a return electrode site only if the patient's elbow has sufficient tissue surrounding it. Align the return electrode with the patient's thigh or arm. (See Diagrams 1 and 2.) Apply firm pressure over the entire surface area of the patient return electrode, particularly the center. In female patients, the thigh has been found to have the highest resistance, but is suitable for most applications.

Connect the plug of the return electrode to the PATIENT receptacle of the generator. Turn the generator ON (READY). If the alarm is not cleared, turn the generator OFF (STANDBY), and unplug the patient return electrode from the generator. DO NOT remove the return electrode from the patient. Proceed to step D.

- d) If the patient is emaciated or extremely thin, apply a third return electrode on the patient's thigh or arm as described in step C. Connect the plug of the return electrode to the PATIENT receptacle of the generator. Turn the generator ON (READY). If the REM™ alarm has not been cleared, turn the generator OFF (STANDBY), unplug the patient return electrode from the generator, and proceed with step E.
- e) Insert a Valleylab Multiple Return Adapter into the PATIENT receptacle of the generator. Insert the plugs of two patient return electrodes which have already been applied, into the adapter. (See Diagram 3.) Choose the two return electrodes which are on the most vascularized, convex areas, in closest proximity to the surgical site. Turn the generator ON (READY).

If the REM™ alarm cannot be cleared by these procedures, use a back–up generator and repeat steps A through E.

Once the REM™ alarm has been cleared, leave the generator ON (READY) during draping to insure that the return electrode(s) is not disturbed. Remove any return electrodes which are not in use.

Diagram 1

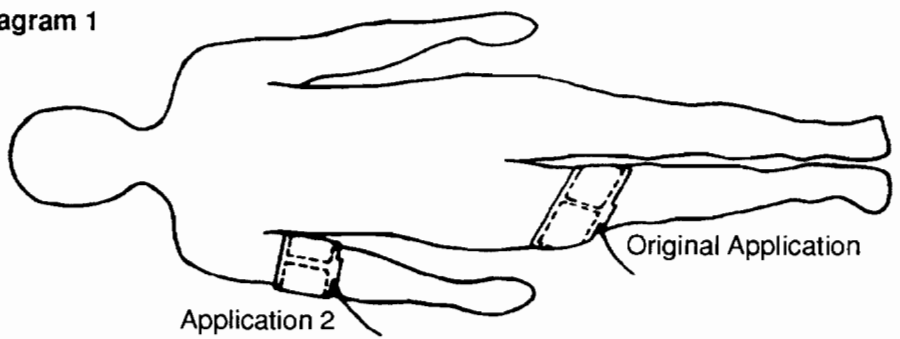

Diagram 2

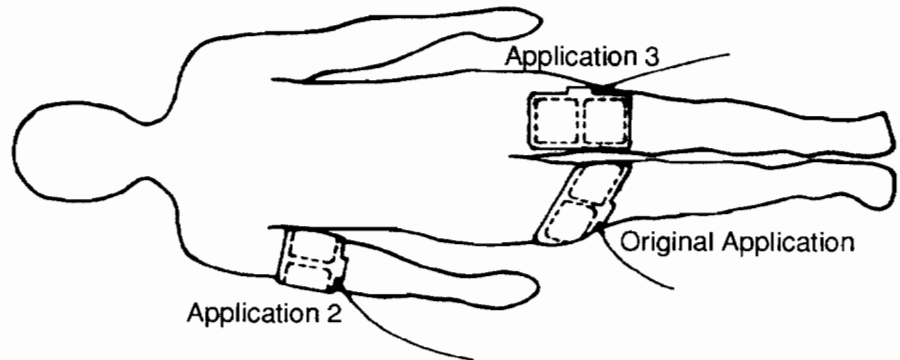

Diagram 3

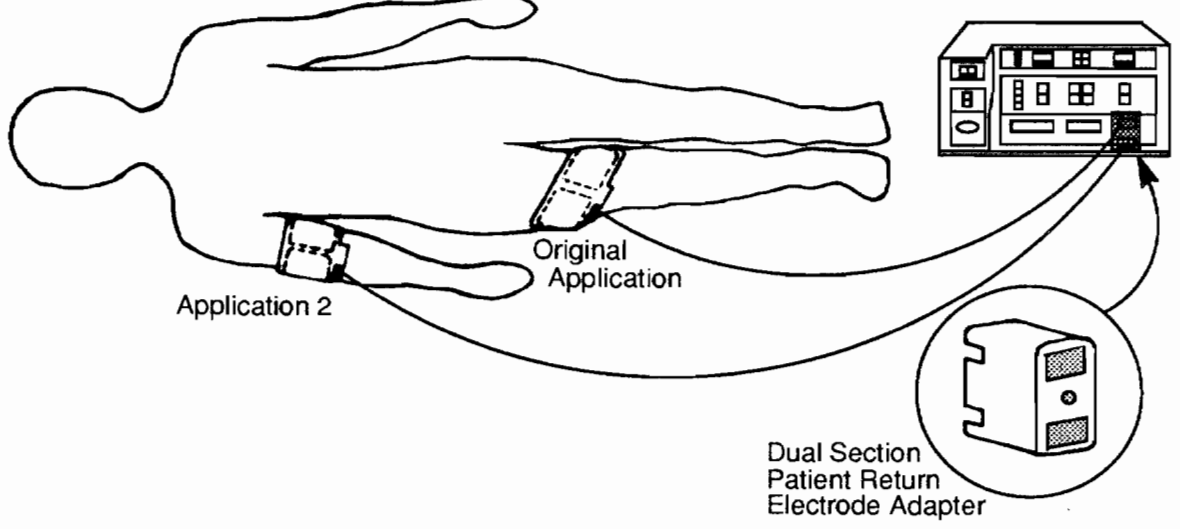

Fig. 17 Silencing the REM™ Alarm

PROBLEM – NO OUTPUT

- a) Generator not plugged in.
- b) Generator not turned on.
- c) Generator in Standby mode.
- d) Fault in handswitching or footswitching accessory.
- e) Patient return electrode not in contact with patient.
- f) Patient return electrode not connected to generator.
- g) Broken patient return electrode cord.
- h) Power set too low.
- i) An internal generator failure; use back-up generator.

PROBLEM – MONITOR INTERFERENCE

Continuous Interference

- a) Check the chassis ground connections for both monitor and generator.
- b) Check all other electrical equipment in the operating room for defective grounds.
- c) If the electrical equipment is grounded to different objects, rather than a common ground, voltage differences can appear between the two grounded objects. The monitor may respond to these voltages. Some types of input amplifiers can be balanced to achieve optimum common mode rejection, and may possibly correct the problem.

Interference Only When Generator Is Activated

- a) Check all connections to the generator, patient return electrode, and active accessory to look for possible metal-to-metal sparking.
- b) Interference is usually greatest during fulguration. The amount of interference can be reduced by using lower power settings or using the Low Voltage Coag mode.
- c) If interference continues when the generator is activated and while the active electrode is not in contact with the patient, the monitor is responding to radio frequencies. Some manufacturers offer RF choke filters for use in the monitor leads. These filters reduce interference while the generator is activated. RF filters minimize the potential for an electrosurgical burn at the site of the monitor electrode.
- d) Check that the ground wires in the operating room are electrically consistent. All ground wires should go to the same grounded metal with wires that are as short as possible.
- e) If the above steps do not remedy the situation, the generator should be checked by qualified service personnel.

PROBLEM – NEUROMUSCULAR STIMULATION

- a) Stop the surgery.
- b) Check all connections to the generator, patient return electrode, and active electrodes to look for a possible metal-to-metal spark.
- c) If no problems are found, the generator should be checked for abnormal 50/60 Hz AC leakage currents.
- d) Neuromuscular stimulation is more likely to occur in the Coag mode when fulgurating than when cutting, and is unlikely when desiccating. Lowering the power setting or using Low Voltage Coag may alleviate the problem.
- e) If the above steps do not remedy the situation, have the generator checked by qualified service personnel.

PROBLEM – PACEMAKER INTERFERENCE

- a) Check all connections of both active and patient return electrode cords to ensure that there is no intermittent or metal-to-metal sparking.
- b) Use bipolar instruments, if possible.
- c) If monopolar instruments must be used, place the patient return electrode as close as possible to the site of surgery and make sure that the current path from the site of surgery to the patient return electrode does not pass through the vicinity of the heart.
- d) Always monitor pacemaker patients during surgery.
- e) Always keep a defibrillator available during electrosurgery on patients with pacemakers.
- f) Consult the pacemaker manufacturer for specific recommendations.

GENERAL ELECTROSURGERY

KEYING/ACTIVATION SYSTEMS

The Force generator can be activated with either a footswitch or by hand-held switching instruments such as forceps or handswitching pencils.

FOOTSWITCHES (Items 3 and 4)

The Force 2 generator may be used with the Valleylab Monopolar and Bipolar footswitches. Both are made of heavy cast metal, have metal protective guards to protect against accidental depression, and are explosion-proof and splash-proof. The cable length on Valleylab footswitches is 10 feet. Footswitch pedals are labeled for cut and coag activation.

HANDSWITCHING FORCEPS AND PENCILS (Items 13, 17 and 5, 15)

The receptacles in the Monopolar section of the jack panel are designed to accept handswitching accessories such as handswitching pencils and monopolar switching forceps. On each receptacle (ACCESSORY, HAND-SWITCH) the banana jack at the extreme left is the active electrode terminal. The second terminal from the left carries the Coag activation signal, so that when the active pin is shorted to the second pin, Coag is activated. When the third pin (far right) is shorted to the active pin, Cut is activated.

If the Power Control Pencil feature is initialized, then the following keying circuit is in effect: When both Cut and Coag terminals are connected to the active terminal, the power setpoint will be decreased; When Cut is connected to Coag, the Power Control Pencil feature is activated or power is increased.

When handswitching bipolar forceps are used, the forceps must have its switching design compatible with the Force 2 generator. That is, the activation must be brought about by switching one of the control leads to the active lead. The four pin Bipolar connector is wired as follows: The switching pins (the two small holes above and below the larger holes) are switched to the large pin on the right which can be thought of as the "active" side of the output. The other large pin (the large hole on the left) can be thought of as the "patient" side of the output, although the only electrical difference between the "active" and the "patient" is the reference of the handswitching input.

For handswitching pencil activation, the Cut and Coag modes of operation are switch-selectable by means of fingertip controls built into the electrode handle. If button switches are used, the switch nearer the active electrode activates the Cut mode. If a rocker switch is used, a forward motion activates the Cut mode. Valleylab handswitching pencils are splash-proof.

USE OF MULTIPLE ACTIVE ELECTRODES

The Force 2 will permit simultaneous, independent use of two active electrodes in the Coag mode when fulgurating from the MONOPOLAR (HAND-SWITCH and ACCESSORY) receptacles. The generator will not permit the use of more than one output in any other modes.

When the first keying command is for Coag power, a second keying command for Coag output at a second electrode will activate the second electrode. Both electrodes are driven in parallel with the indicated Coag power output shared between them. The percentage of power delivered to each electrode will depend on the impedance between the active electrode and the patient return electrode. The lower impedance electrode will receive the most power. If one electrode is in good contact with moist

tissue, the second electrode may have insufficient voltage available for sparking and may fulgurate poorly.

High voltage relays connect the first and second outputs. These relays cannot be opened or closed while current is flowing through them. For this reason there is a momentary cessation of generator output when the second Coag output is activated or released.

There are three outputs which can be connected concurrently, but not activated simultaneously. There are two MONOPOLAR outputs; one keyed at the pencil and the other keyed by the footswitch or handswitch. The third output, MICROBIPOLAR, can be operated by keying the output with a handswitching forceps, or by selecting the bipolar footswitch mode on the front panel and keying the output with the monopolar footswitch, or by using a bipolar footswitch.

PATIENT RETURN ELECTRODES

When using monopolar active electrodes, a patient return electrode is ALWAYS required. The patient return electrode serves as a means for the current to leave the patient's body safely and return to the generator. The patient return electrode must be considerably larger than the active electrode so that the current density is kept low and no significant heating occurs. Because the patient return electrode is not grounded at low frequencies, we refer to it as a "patient return electrode" and not as a "ground plate." By not calling it a ground plate, we hope to avoid the assumption that the patient return electrode is a convenient ground for ECG's or other purposes.

Suggested Placement Areas

Select a well vascularized, convex area in close proximity to the surgical site for electrode application.

Avoid scar tissue, bony prominences, adipose tissue and areas where fluid may pool.

Follow the instructions for use supplied by the patient return electrode manufacturer.

REM™ POLYHESIVE®II PATIENT RETURN ELECTRODE (Not supplied in military kit)

The Valleylab REM™ Patient Return Electrode is a disposable conductive adhesive pad with two sections totaling 58.5 cm² surface area for RF currents. The conductive adhesive surface is a specially formulated, water base polymer which performs like gel but with no gel mess. It conforms to and fills body surface irregularities, will not stick to hair, is non-irritative to skin, and helps reduce the skin's natural electrical resistance.

The electrode has an adhesive border as well as the conductive adhesive surface, so the entire pad adheres to the skin.

The PolyHesive®II electrode is designed for use with the Valleylab REM™ Contact Quality Monitoring System. A center pin on the return cord connector activates the REM™ circuit in the generator when plugged into the PATIENT receptacle.

Cautions

Do not use electrode if package seal is broken or conductive adhesive has become dry.

Do not attempt to relocate the patient return electrode after initial application.

Electrode gel is not required and should not be used.

Single use item. Do not reuse.

Instructions for Use

- a) Take the patient return electrode from the pouch and remove backing paper.
- b) Lightly touch the surface of the gel to assure that the conductive adhesive is moist.
- c) Shave, clean and dry application site as needed.
- d) Pull the patient return electrode taut and apply it to the patient on the bias for better adhesion.

- e) Apply finger pressure to adhesive border and massage entire pad area to ensure adequate contact with the patient's skin.
- f) Prior to inserting the patient return electrode connector into the generator, turn the generator ON (STANDBY) to ensure that the alarm system is operating properly.
- g) Insert the connector to silence the alarm.
- h) Following surgical procedure, remove patient return electrode slowly to avoid skin trauma.

CONVENTIONAL, SINGLE-SECTION PATIENT RETURN ELECTRODES

If the Force 2 generator is to be used with a conventional, single-section patient return electrode, the following care should be taken:

If this type of pad is used, the REM™ Contact Quality Monitoring System is bypassed. The patient return circuitry then only monitors overall connector, cord, and pad continuity. If the impedance between the two wires in the return cord increases above 20 ohms, the REM™ alarm will sound. The REM™ System will not monitor patient-to-pad contact area integrity if a single-section patient return electrode is used. If this type of patient return electrode is used, a patient burn may occur without an alarm.

The Permanent Patient Plate (Item 6)

This is a permanent, stainless steel plate which connects to the patient return cord. The cord has a connector at the generator end and connects to the PATIENT receptacle. The wire insulation should be inspected routinely for defects.

The metal patient plate is designed to go under the buttocks, thigh, shoulder or anywhere that gravity can insure an adequate contact area. We recommend the use of conductive gel to insure that the skin is wet and that the plate is in good electrical contact with the skin.

The Disposable Patient Plate (Not supplied in military kit)

The Disposable Patient Plate Electrode is similar in size and application to the metal plate discussed above. It is made from cardboard which is covered with non-anodized aluminum foil.

Like the Permanent Patient Plate, the Disposable Patient Plate electrode is designed for use with a conductive gel. Because this patient plate is flexible, it is possible to wrap it around a leg and tape it in place. If used with gel, this scheme is acceptable electrically, but the user should be aware of the possibility of thromboembolism due to restriction of the venous return.

The PolyHesive® Patient Return Electrode (Item 14)

This patient return electrode has a disposable foam pad. The conductive adhesive surface is a specially formulated, water base polymer which performs like gel but with no gel mess. It conforms to, and fills, body surface irregularities, will not stick to hair, is non-irritative to skin, and helps reduce the skin's natural electrical resistance.

The electrode has an adhesive border as well as the adhesive conductive surface, so the entire pad adheres to the skin. In case of suspected circuit problems, do not assume that the PolyHesive® pad is in good contact with the skin just because it looks right from the outside. Remove the PolyHesive® from the skin and replace it with a new pad. NEVER reapply a used pad.

NEVER CUT THE POLYHESIVE® TO A SMALLER SIZE FOR PEDIATRIC USE! It is possible to set the small infant down on the conductive pad or wrap the PolyHesive® around the infant. A PolyHesive® Pediatric Return Electrode is also available from Valleylab.

THE REM™ CONTACT QUALITY MONITORING SYSTEM

The Valleylab REM™ Contact Quality Monitoring System employs a two–section REM™ patient return electrode (not supplied in military kit). Circuitry within the Force 2 generator measures the impedance between the two sections of the patient return electrode and the patient's body to determine the actual contact impedance with the patient. Both sections of the electrode provide return paths for RF currents. The REM™ system ensures that RF currents pass through an adequate amount of surface area on the patient return electrode and that minimum current division to other grounded points occurs. The system will disable the generator and signal a fault condition both audibly and visually if improper impedance is detected.

The REM™ System ensures adequate patient contact area by measuring the resistance between the two sections of the patient return electrode through the patient. Both sections of the pad and both connector pins carry the RF currents. The pin–to–pin resistance measurement is performed continuously, even when the generator is activated. The measurement uses small currents at 140 kHz and will not produce nerve stimulation or interfere with ECG monitors. The alarm levels have hysteresis so that small changes in resistance will not cause intermittent alarms.

REM™ will alarm and disable the generator under the following conditions:

1. The patient return electrode is not plugged into the generator.
2. A broken patient return electrode cord.
3. The patient return electrode is not in contact with patient.
4. Reduction of patient return electrode contact area due to movement, loss of adhesion, or drying of contact gel.
5. Excessive impedance in the patient return electrode cord.

The REM™ Contact Quality Monitor is activated when a REM™ Patient Return Electrode connector is inserted in the PATIENT receptacle. A pin on the connector actuates a switch that indicates to the generator the type of patient return electrode being used.

If a conventional, single–section patient return electrode is used, the REM™ system will monitor the pin–to–pin resistance at the connector and is capable of detecting broken wires or connectors in the patient return electrode cord.

REM™ IS NOT ABLE TO MONITOR THE PATIENT CONTACT AREA IN CONVENTIONAL, SINGLE–SECTION PATIENT RETURN ELECTRODES.

The Force 2 generator uses “adaptive” REM™. After the patient return electrode is applied and the initial impedance is between 5 and 135 ohms, the REM™ system measures the contact impedance and uses it as a reference value. If the patient–to–pad impedance increases 40% above this reference value, or above 135 ohms, the REM™ alarm sounds and the generator is disabled. In this way, the adaptive REM™ system is designed to calibrate itself with respect to individual patients.

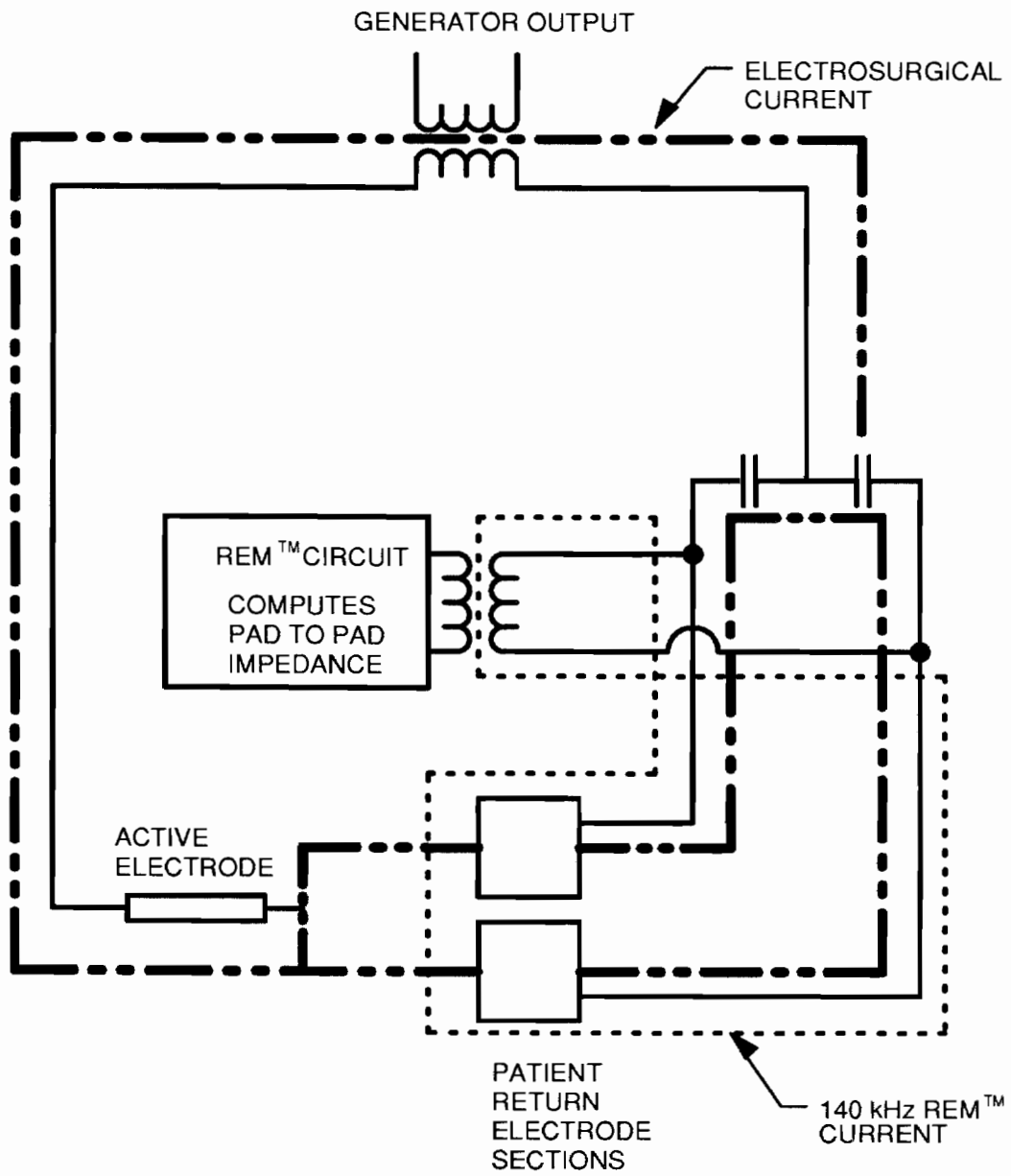

Fig. 18 REM™ System Schematic

TECHNICAL SPECIFICATIONS

In this Section, "typical" refers to a specification that is within 20% of a stated value.

OUTPUT WAVEFORM

Cut	500 kHz sinusoid
Blend 1	500 kHz bursts of sinusoid at 50% duty cycle recurring at 31 kHz
Blend 2	500 kHz bursts of sinusoid at 37.5% duty cycle recurring at 31 kHz
Blend 3	500 kHz bursts of sinusoid at 25% duty cycle recurring at 31 kHz
Coag	500 kHz damped sinusoidal bursts with a repetition frequency of 31 kHz
Low Volt Coag	500 kHz bursts of sinusoid at 25% duty cycle recurring at 31 kHz
Bipolar	500 kHz sinusoid, unmodulated

OUTPUT CHARACTERISTICS

Mode	Maximum (open circuit) P-P Voltage	Rated Load (Ohms)	Nominal Power (at Rated Load) (Watts)	Crest Factor at Rated Load (typical)
Cut	3000	300	300	1.9 @ 100W
Blend 1	3500	300	250	3.3 @ 100W
Blend 2	3700	300	200	4.0 @ 100W
Blend 3	4000	300	150	4.8 @ 100W
Coag	7000	300	120	9.0 @ 50W
Low Volt Coag	4000	300	99	4.8 @ 100W
Bipolar	800	100	70	2.0 @ 40W

Power readouts agree with actual power into rated load to within $\pm 15\%$ or 5 watts, whichever is greater.

LOW FREQUENCY LEAKAGE (50/60 HZ)

Source current, patient leads, all outputs tied together.

Normal polarity, intact chassis ground	< 10 microamperes
Normal polarity, ground open	< 100 microamperes
Reverse polarity, ground open	< 100 microamperes
Sink current, 140V applied, all inputs	< 150 microamperes
Chassis source current, ground open	< 100 microamperes

HIGH FREQUENCY RISK PARAMETERS

Bipolar RF leakage current	< 150 milliamperes.
Monopolar RF leakage current	< 150 milliamperes.

REM™ CONTACT QUALITY MONITOR

Measurement Frequency 140 kHz ± 20 kHz
Measurement Current 3.0 mA max

Acceptable Resistance Ranges:

Single-area pad nominally < 20 ohms
Dual-area REM™ pad nominal range 5 – 135 ohms

If impedance measured is outside the acceptance range, a REM™ fault condition will occur. In the REM™ mode, if resistance increases by more than 40% above the reference value, or above 135 ohms, an alarm will be generated .

INPUT POWER SOURCE

Nominal Voltage:	115 Volts RMS	or	220 Volts RMS
Regulation Voltage:	95–140 Volts RMS	or	190–270 Volts RMS
Operating Range:	85–140 Volts RMS	or	170–275 Volts RMS
Current	Idle: 0.4 A, max	or	0.2 A, max
	Cut: 9 A, max	or	6 A, max
	Coag: 4 A, max	or	1.5 A, max
	Bipolar: 3 A, max	or	0.75 A, max

POWER CORD LENGTH

15 feet

AUDIO VOLUME

Mode indicator tones are adjustable from 45 dBA minimum to > 65 dBA at 1 meter maximum. The Force 2 has two distinctly different mode indicator audio tones to indicate either the Cut or the Coag/Bipolar activations. The mode indicator audio tones are adjustable. The alarm tones are not adjustable.

DISPLAYS/CONTROLS

The front panel controls and indicators of the Force 2 are visible and clearly identifiable from a distance of at least 8 feet (2.5 meters).

WEIGHT

23 lbs., 10.4 kg

SIZE

8 x 13 x 21 inches, 20 x 33 x 53 cm

Specifications subject to change without notice.

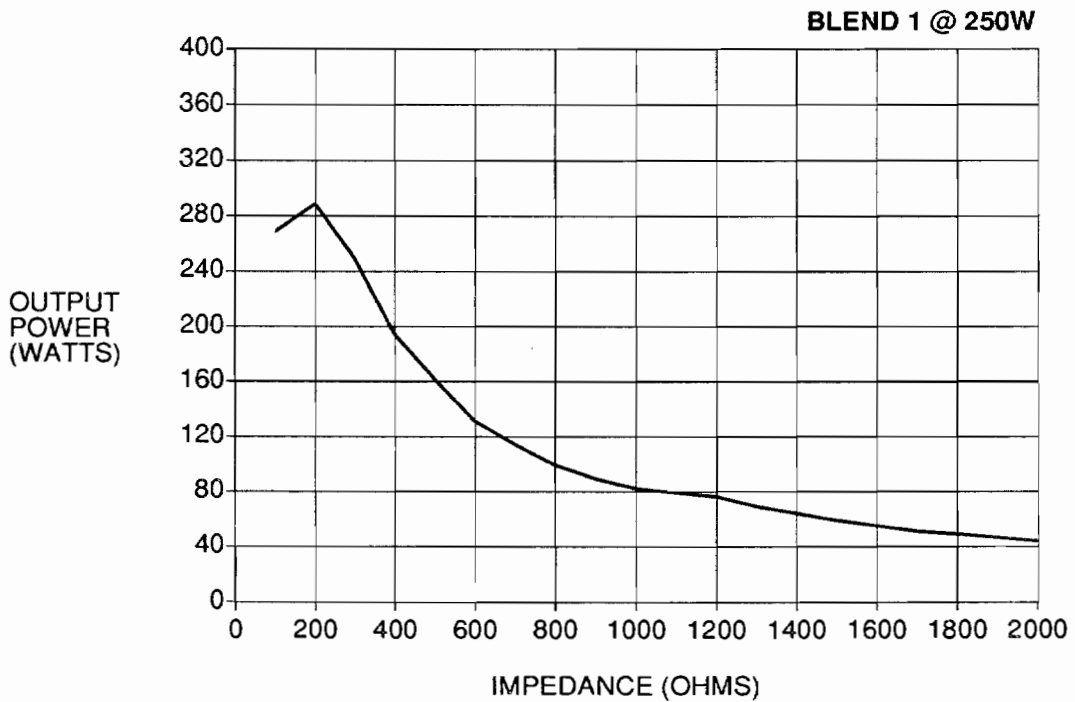
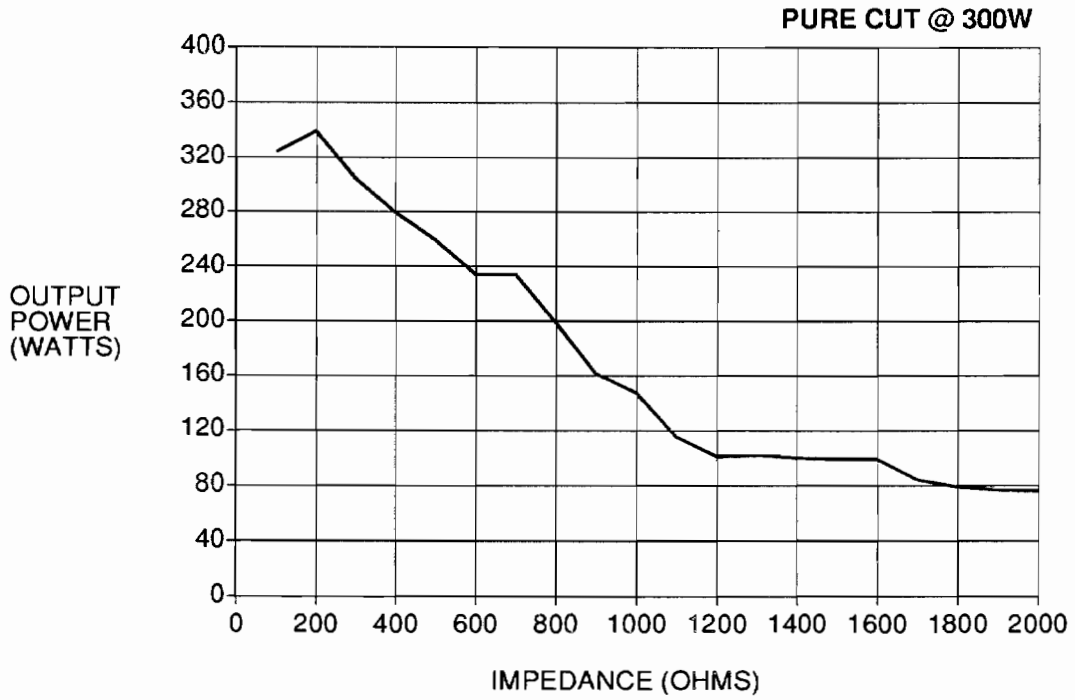

Fig. 19 Typical Output Power vs Load – Monopolar Cut Modes

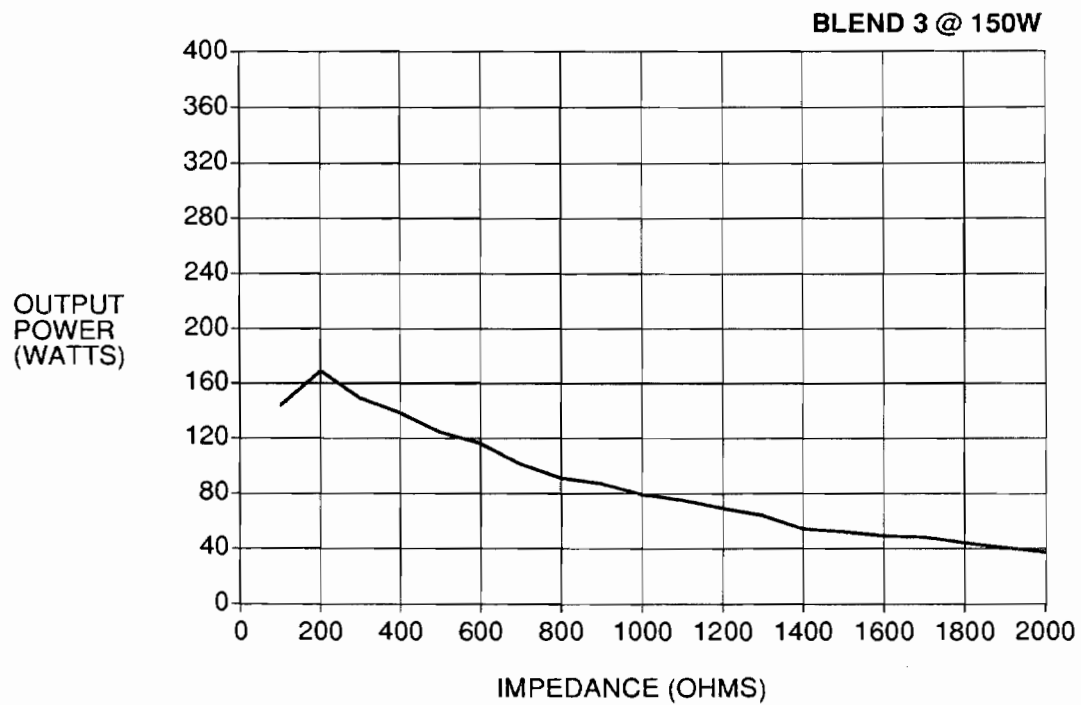
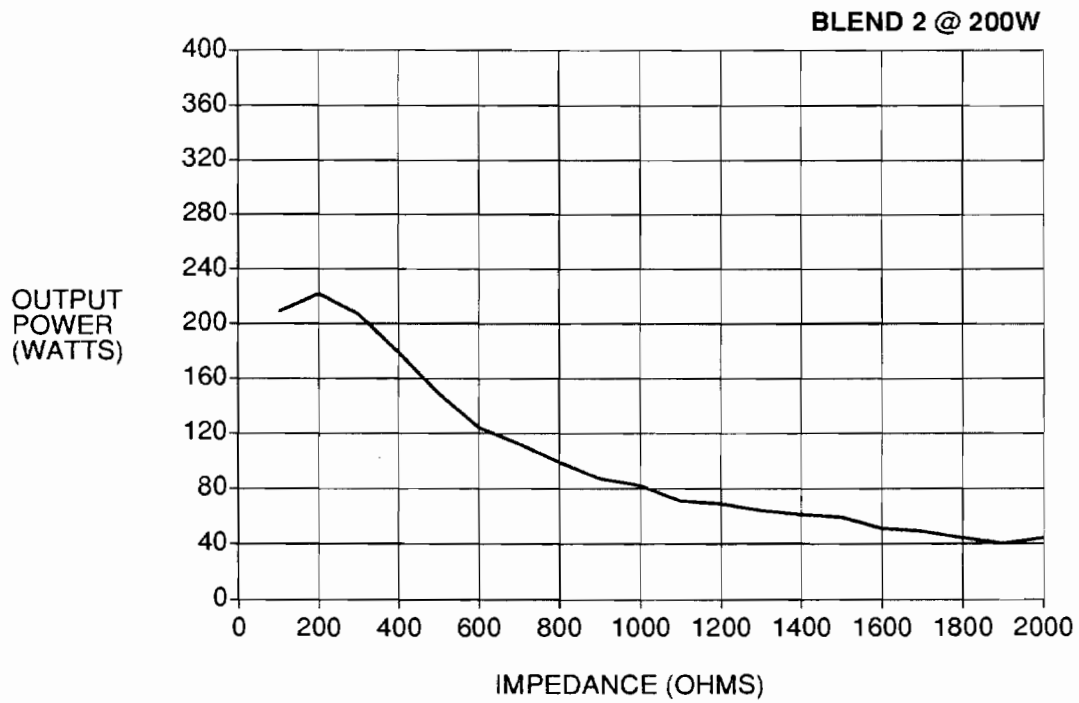

Fig. 19 Typical Output Power vs Load – Monopolar Cut Modes (Continued)

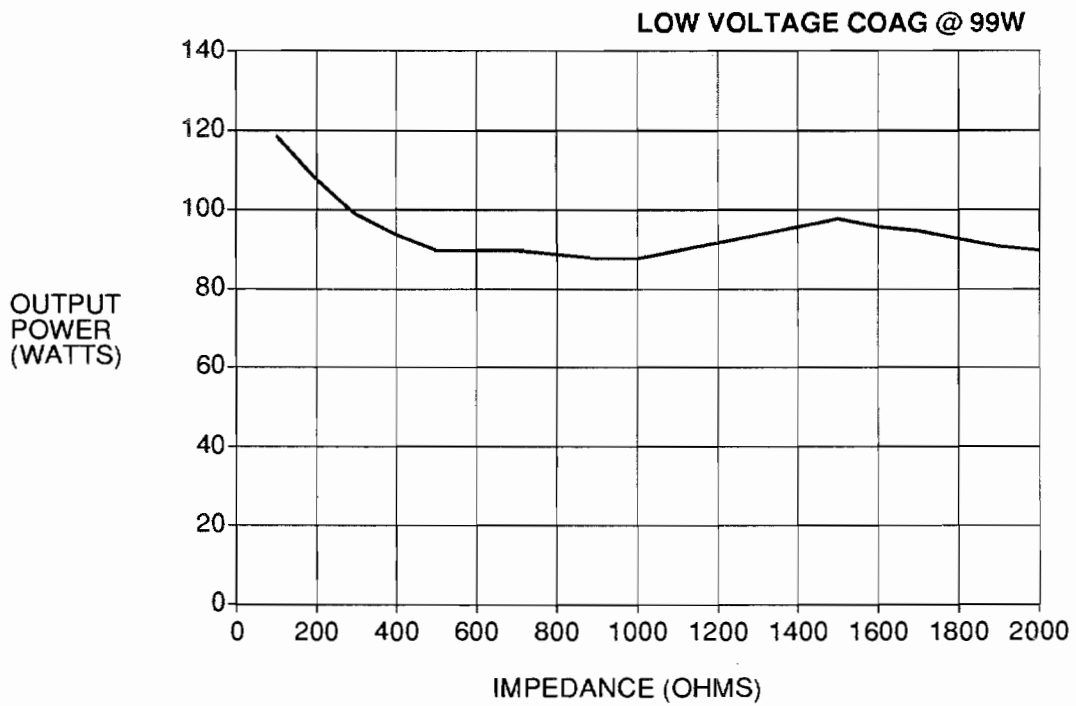
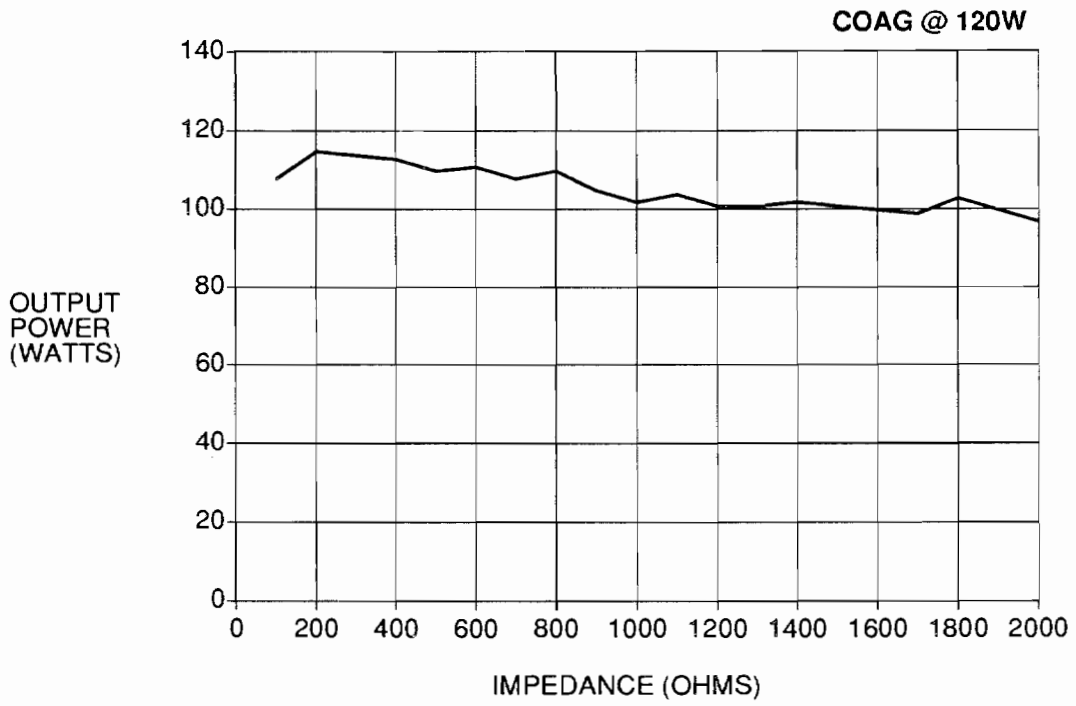

Fig. 20 Typical Output Power vs Load – Coag Modes

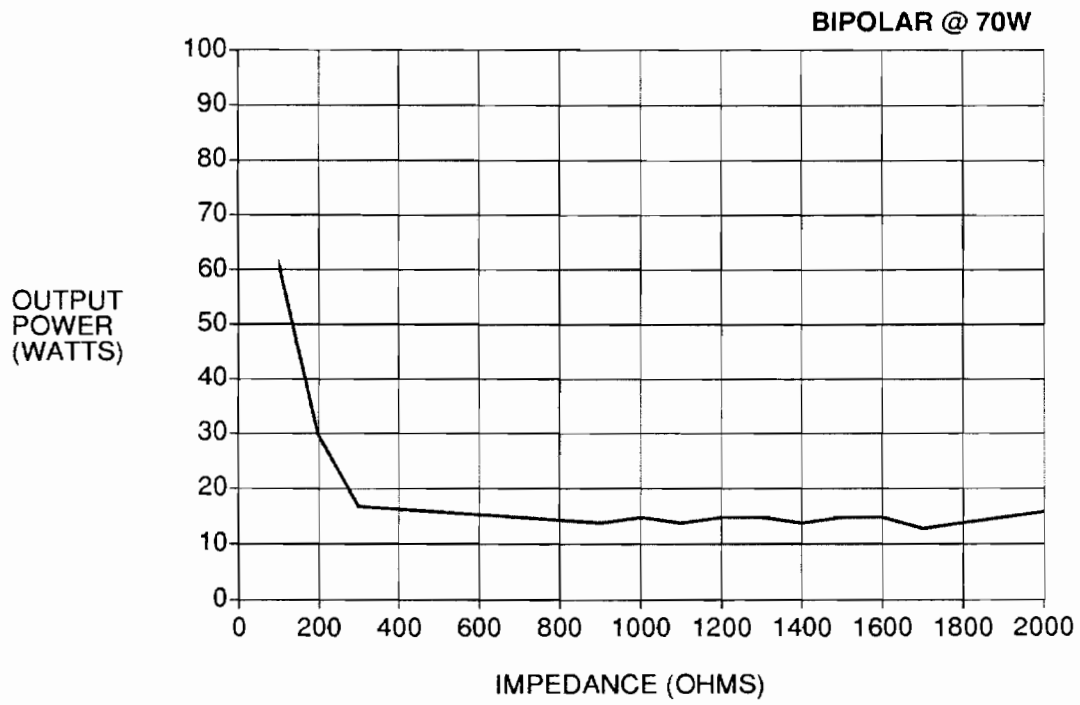

Fig. 21 Typical Output Power vs Load – Bipolar

GLOSSARY

AC LEAKAGE CURRENT – Any 50/60 Hz current, including capacitively-coupled currents, which may be conveyed from accessible parts of the electrosurgical accessories to ground, or through the patient to ground.

ACTIVE CORD/CABLE – The conductor between the electrosurgical generator and the active electrode.

ACTIVE ELECTRODE – The electrode at which the electrosurgical effect is intended. It is usually a small area and provides a high current density to achieve the intended surgical effect.

BIPOLAR INSTRUMENT – Forceps or other electrosurgical accessories having two electrodes, both of which are intended to be applied to the tissue undergoing electrosurgical treatment. These electrodes are energized by the electrosurgical generator so that the current passes between the electrodes. It is intended that a substantial portion of the total current is restricted to tissue between the electrodes.

BIPOLAR OUTPUT – An isolated generator output. See Microbipolar.

BLEND – An electrosurgical output which is intermediate in crest factor between Cut and Coag. It is best for cutting tissue, while at the same time providing excellent hemostasis. Blend can be thought of as a “mixture” of Cut and Coag.

COAG – Electrocoagulation. To coagulate. The name of the voltage waveform or generator output that is optimized for the fulguration of tissue.

COAGULATE – In electrosurgery, a general term which includes the fulguration and desiccation of tissue. To cause to clot; to achieve hemostasis; to kill tissue with electrosurgery without severing it.

CREST FACTOR – The ratio of the peak voltage to the root mean square (RMS) voltage of a periodic waveform. In electrosurgery, generally the outputs with high waveform crest factors are better for fulgurating tissue.

CUT – In electrosurgery, the name of the voltage waveform or generator output which is optimized for dividing tissue with a minimum of coagulation. A generator output with a low crest factor, typically 1.4 to 2.0. Tissue division with a fine electrosurgical electrode. Electrocut. Electrocision. Electrotomy.

DESICCATION – The dehydration and necrosis of tissue caused by passing a radio frequency electric current through the tissue. In desiccation, the electrodes must be in good electrical contact with the tissue, and the current heats the tissue by dissipating power in the electrical resistance of the tissue. Desiccation differs from fulguration in that there is no sparking between the electrode(s) and the tissue. See Fulguration.

ELECTRODE – Either terminal of an electric current through which electricity is received or transmitted. In electrosurgery, it is the conductive metal (active) or conductive pad (return) or assembly (such as forceps) which actually contacts the patient’s body. In electrosurgery, two electrodes are required and, in monopolar applications, are generally dissimilar in size. The smaller, “active” electrode, is intended to be the site of the electrosurgery, while the larger “patient return” electrode, merely completes the circuit path back to the generator.

FULGURATION – Coagulating tissue or blood by means of radio frequency electric sparks. In contrast to desiccation, the active electrode is not in good electric contact with the tissue and sparks jump from the electrode to the tissue. Fulguration is literally the reducing of tissue to carbon.

GROUND – Wires and conductors connected to the earth. Grounded conductors all have the same voltage, so no dangerous currents can flow between them.

GROUND PLATE – A patient return electrode which is connected directly to earth ground.

IMPEDANCE – The resistance to flow of an AC or radio frequency electric current. The term impedance includes not only simple DC resistance, but also the resistance to flow brought about by capacitance and inductance in a circuit.

ISOLATED GENERATOR OUTPUT – A generator output which has no reference to ground. In order for current to flow there must be a complete circuit path from the active electrode to the patient return electrode. Isolated outputs are required for good operation with bipolar instruments.

LEAKAGE CURRENT – A small current which flows along an undesired circuit path, usually to ground.

MEASUREMENT CURRENT – A current intentionally applied to the patient's body to measure the adequacy of contact between the patient and the patient return electrode or other variables related to the function of safety features.

MICROBIPOLAR – A Valleylab term for an isolated, low power generator output which is optimized for desiccating tissue. Specifically, the Microbipolar output is designed for bipolar neurosurgical forceps, bipolar laparoscopic forceps, etc..

PATIENT CORD/CABLE – The cord or wire which connects the patient return electrode to the patient receptacle on the generator.

PATIENT RETURN ELECTRODE – The electrode at which no electrosurgical effect is intended. It is usually large in area in order to provide a low current density so that no electrosurgical effect occurs at that site. It is also known as a dispersive electrode, patient plate, return electrode, inactive electrode, inert electrode, and indifferent electrode. If actually connected to earth ground, it is also appropriate to call it a "ground plate".

RF – Radio frequency. A high frequency alternating current. "Radio" generally means a frequency greater than 100,000 Hz (cycles/second).

RADIO FREQUENCY LEAKAGE CURRENT – The maximum current which can flow to ground from an isolated generator output when one side of the output is wired directly to earth ground.

RETURN ELECTRODE – See patient return electrode.

REM™ – A safety system on all Valleylab Electrosurgical Generators which continuously monitors the contact impedance of the patient return electrode and sounds an alarm if the impedance rises above safe limits.

SINK LEAKAGE CURRENT – The maximum current which can flow into a patient-connected lead (patient return electrode, active electrode, etc.) when current at 50/60 Hz AC is applied to that patient lead. The lead itself produces no current but passively accepts current flowing to ground when a ground-referenced power source (the line voltage) is applied to the patient by accident.

SOURCE LEAKAGE CURRENT – The maximum 50/60 Hz current which will flow out of the chassis, patient return electrode, or active electrode when touched to a grounded object. In contrast to sink leakage, source leakage is active, that is, it provides a current which could flow through the patient or person touching the generator or accessories.

LIMITED WARRANTY

Valleylab, Inc. warrants each product manufactured by it to be free from defects in material and workmanship under normal use and service for the period(s) set forth below. Valleylab's obligation under this warranty is limited to the repair or replacement, at its sole option, of any product, or part thereof, which has been returned to it or its Distributor within the applicable time period shown below after shipment of the product to the original purchaser, and which examination discloses, to Valleylab's satisfaction, that the product is defective. This warranty does not apply to any product, or part thereof, which has been repaired or altered outside of Valleylab's factory in a way so as, in Valleylab's judgment, to affect its stability or reliability, or which has been subjected to misuse, negligence or accident.

The warranty periods for Manufacturer's products are as follows:

ELECTROSURGICAL GENERATORS	One Year from date of shipment.
Mounting Fixtures (all models)	One Year from date of shipment.
Footswitches (all models)	One Year from date of shipment.
Return Electrodes	Shelf life only, as stated on packaging.
Sterile Disposables	Sterility only, as stated on packaging.

THIS WARRANTY IS IN LIEU OF ALL OTHER WARRANTIES, EXPRESS OR IMPLIED, INCLUDING THE WARRANTIES OF MERCHANTABILITY AND FITNESS, AND OF ALL OTHER OBLIGATIONS OR LIABILITIES ON THE PART OF VALLEYLAB. VALLEYLAB NEITHER ASSUMES NOR AUTHORIZES ANY OTHER PERSON TO ASSUME FOR IT ANY OTHER LIABILITY IN CONNECTION WITH THE SALE OR USE OF ANY OF VALLEYLAB'S PRODUCTS. THERE ARE NO WARRANTIES WHICH EXTEND BEYOND THE TERMS HEREOF.

This warranty and the rights and obligations hereunder shall be construed under and governed by the laws of the State of Colorado, U.S.A.

Valleylab, Inc., its dealers and representatives, reserve the right to make changes in equipment built and/or sold by them at any time without incurring any obligation to make the same or similar changes on equipment previously built and/or sold by them.

APPENDIX

The following pages contain the individual operating and cleaning instructions for the F2-20 PC MIL ElectroSurgical Apparatus accessories.

E8006 Mobile Cart (item 2)

CONTENTS

<u>QTY</u>	<u>DESCRIPTION</u>	<u>VALLEYLAB PART NUMBER</u>
4	Caster	213 200 003
2	#8 Nylon Finger Screw	237 100 552
2	#10 Phillips Head Screw	237 100 551
2	#10 Wing Nut	224 035 000
2	Fender Washer	253 100 045

ASSEMBLY INSTRUCTIONS

1. Turn the cart upside down and fully insert the four casters into the sockets on the base. Place the cart right side up on the wheels.
2. Slightly loosen the two front wing nuts (one on each side) that attach the top to the cart base.
3. Remove the two rear wing nuts and screws and select one of three rear mounting positions for the desired top angle.
4. Attach the rear of the top with four screws and wing nuts (two each previously removed, and two each supplied). Tighten all six screws to secure the top.
5. Always use the cart handle to maneuver the cart.

GENERATOR TO CART ATTACHMENT

1. Assure that the top mounting surface is at the desired angle and has been secured.
2. Remove two of the bottom feet on opposite corners of the generator. The feet removed will not be used for mounting. Retain the rubber collars.
3. Center the two rubber collars over the grommets on the cart which match the locations of the removed generator feet. Place the generator on the cart top.
4. From the inside of the cart top, use two fender washers and two nylon finger screws to attach the generator to the cart, using the existing threads in the generator chassis. Tighten these finger tight only.

CLEANING

Clean the cart using standard operating room procedures. Do not use caustic, corrosive, or abrasive cleaning materials.

Manufactured for Valleylab, Inc., Boulder, CO 80301 USA

E6008 Monopolar Footswitch (item 3)

INSTRUCTIONS FOR USE

Connect the footswitch to the electrosurgical generator according to the instructions in the generator instruction manual. Follow the generator manual instructions for selecting generator footswitch controls.

CLEANING

To assure safe and reliable operation of this footswitch, routinely clean the device following hospital standard procedure for cleaning and disinfecting surgical equipment. Do not use caustic, corrosive, abrasive, or hydrocarbon solvent cleaning materials. Do not allow fluids to enter the switch.

INSPECTION AND OPERATIONAL TESTING

Valleylab recommends that this operation be followed semiannually, or more frequently, as required.

1. Inspect the cable and footswitch to ensure that there are no exposed wires or other visible damage. Replace if necessary.
2. Connect the footswitch to a functional electrosurgical generator. Refer to the generator instruction manual for the proper procedure.
3. Activate the CUT and COAG pedals separately to verify that the correct generator function is activated.
4. Disconnect the footswitch from the generator.
5. Rest one hand on the pedal labeled CUT while slowly depressing the other pedal labeled COAG up and down three times. During this cycling no movement should be felt in the CUT pedal.
6. Repeat this test by depressing the CUT pedal and sensing for any movement in the COAG pedal. In both tests the pedal being cycled must move freely, that is, no binding and/or hesitation should be felt. If any binding or hesitation is felt, return the footswitch to Valleylab, Inc. for service.

REPLACEMENT PARTS LIST

<u>DESCRIPTION</u>	<u>VALLEYLAB PART NUMBER</u>
Divider Bar	223 600 009
Base	222 700 000
Rubber Feet	213 110 184
Cable Assembly	202 400 212
Strain Relief	213 150 009
CUT Label	216 100 013
COAG Label	216 100 012
Rivets	237 600 020
Switch	243 068 000

Manufactured for Valleylab, Inc., Boulder, CO 80301 USA

E6009 Bipolar Footswitch (item 4)

INSTRUCTIONS FOR USE

Connect the footswitch to the electrosurgical generator according to the instructions in the generator instruction manual. Follow the generator manual instructions for selecting generator footswitch controls.

CLEANING

To assure safe and reliable operation of this footswitch, routinely clean the device following hospital standard procedure for cleaning and disinfecting surgical equipment. Do not use caustic, corrosive, abrasive, or hydrocarbon solvent cleaning materials. Do not allow fluids to enter the switch.

INSPECTION AND OPERATIONAL TESTING

Valleylab recommends that this operation be followed semiannually, or more frequently, as required.

1. Inspect the cable and footswitch to ensure that there are no exposed wires or other visible damage. Replace if necessary.
2. Connect the footswitch to a functional electrosurgical generator. Refer to the generator instruction manual for the proper procedure.
3. Activate the pedal to verify that the correct generator function is activated.

E2502B Reusable Handswitching Pencil (item 5)

INSTRUCTIONS FOR USE

1. Open the package by peeling it apart at the arrow indicated on the lid.
2. Remove the Reusable Handswitching Pencil from the package using aseptic technique. Remove and discard the blade tip protector and the band from around the pencil and cord.
3. Check the electrode connection for secure fit. The Valleylab electrode is designed to lock in place to prevent rotation. To change the electrode orientation, pull the electrode out, rotate it, then re-insert it into the pencil. The pencil will also accept standard 3/32" (2,4mm) non-locking electrodes.
4. Insert the plug connector into the active HAND-SWITCH receptacle on the electrosurgical generator.

CAUTION: Improper electrode installation may result in injury to the patient or operating room personnel by arcing at the electrode/pencil connection.

WARNING: Keep active accessories away from the patient when not in use. An accessory holster (Valleylab Catalog No. E2400) may be used to hold active accessories safely.

CLEANING

1. This Pencil should be processed with other delicate surgical instruments in order to protect the electronic components.
2. If a disposable electrode has been used in the Pencil, remove and discard. Remove all gross matter (blood, mucous, tissue) by wiping the entire Pencil with a cloth or gauze pad and a mild cleaning solution or blood dissolving detergent. Remove any cleansing agents by wiping the Pencil with a water dampened cloth. Do not immerse the Pencil in reprocessing solutions.
3. Dry thoroughly.
4. Sterilize the pencil using standard hospital procedures for Ethylene Oxide sterilization or steam autoclave sterilization, following the handling recommendations below.

ETHYLENE OXIDE PROCESSING

1. Coil the cord loosely prior to inserting the Pencil into an EtO pouch. Tight "bunching" or wrapping of the cord will decrease the useful life of the Pencil.

STEAM AUTOCLAVE PROCESSING

1. Do Not Autoclave This Pencil Unwrapped.
2. Lay the pencil body in the center of the wrapping material as shown (Fig. 1).
3. Fold the material over the pencil body and proceed to coil the cord around the material lengthwise (Fig. 2).

NOTE: Keep the pencil body, cord and plug connector from contacting each other to prolong the life of the pencil. Do not use rubber bands, string, or tape to secure the cord.

4. Apply a second wrapping material to the packet produced in Step 2 above (Fig. 3) Tape and autoclave.
5. Do not exceed a processing temperature of 135°C (275°F) for 20 minutes. The number of uses will be reduced when this product is steam autoclaved.

Recommended wrapping procedure for normal autoclaving

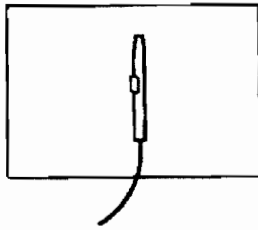

Fig. 1

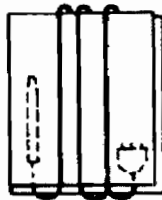

Fig. 2

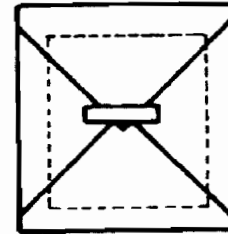

Fig. 3

TESTING

During surgical procedure set up, confirm product function.

1. Insert the Reusable Pencil connector into the active handswitch receptacle on the Valleylab electrosurgical generator. The patient return electrode must be in place on the patient.
2. Using the ON/OFF switch located at the rear of the generator, turn the generator ON.
3. When dashes appear on the display, press the READY button located on the front panel of the generator.

CAUTION: Set Cut and Coag power settings to 1 Watt before testing the pencil.

NOTE: Observe the generator as it goes from standby to ready. If either one of the Cut or Coag power output indicators (WATTS lamps) illuminates or if a single tone sounds, discard pencil.

4. Press the yellow CUT button on the pencil and verify that the WATTS lamp in the Cut mode illuminates. If Coag WATTS lamp illuminates, discard the pencil.
5. Press the blue COAG button on the pencil and verify that the WATTS lamp in the Cut mode illuminates. If Coag WATTS lamp illuminates, discard the pencil.

NOTE: If either the Cut or Coag WATTS lamp does not illuminate, discard the pencil.

6. Press the STANDBY button located on the front panel.

E7001–1R Patient Return Electrode (item 6)

This product is supplied non–sterile.

A patient return electrode is always required when monopolar outputs of the generator are in use.

The E7001–1R requires the Valleylab E0009–1R Patient Return Cord

INSTRUCTIONS FOR USE

1. Connect the cord to the patient return electrode by screwing the cord connectors onto the threaded studs. Save the plastic protective caps to protect the threads of the return electrode when not in use. Be sure that the threaded connections are fully engaged. Refer to the electrosurgical generator instruction manual for proper procedures for connecting the cord to the PATIENT receptacle of the generator.
2. If the generator detects an incomplete circuit a REM™ alarm will occur. Recheck all connections between the generator, cord and patient return electrode. Replace the cord if required.
- 3.. Apply conductive gel (E5501, item 7) to one side of the patient return electrode, distributing the gel as uniformly as possible across the entire plate surface.
4. Place the patient return electrode under the patient with the gelled side against the patient's skin. Recommended positions for application are under the buttocks, thighs, shoulders, or any location where gravity can ensure adequate contact area. Avoid obstructions between the patient and the Patient Return Electrode such as surgical drapes or ace wraps. Assure that the patient is in firm contact with at least half the Patient Return Electrode surface.
5. If the patient is repositioned after initial application, check the Patient Return Electrode site to be sure that the patient is still in full contact with at least half the Patient Return Electrode surface. During lengthy procedures, check the gel frequently. If the gel becomes dry, reapplication is necessary.

PRECAUTIONS

For safe operation at generator power settings up to 400 watts, the patient must be in full contact with at least half of the Patient Return Electrode surface.

NOTE: Use of this patient return electrode with an E0009–1R Cord does not enable the REM™ Contact Quality Monitoring System to monitor impedance at the patient return electrode site. Only the continuity of the Patient Return Electrode and Cord circuit to the generator is monitored.

CLEANING

The Patient Return Electrode may be cleaned using any hospital–grade detergent. Care should be taken to ensure that the threaded studs for cord attachment are clean to provide good electrical contact. Dry the Patient Return Electrode thoroughly.

Manufactured for Valleylab, Inc., Boulder, CO 80301 USA

E0009–1R Cord (item 6)

This product is supplied non–sterile.

This Cord is designed for use with the Valleylab E7001–1R Patient Return Electrode.

NOTE: Use of the E0009–1R Cord and E7001–1R Patient Return Electrode does not enable the REM™ Contact Quality Monitoring System to monitor impedance at the patient return electrode site. Only the continuity of the Patient Return Electrode and Cord circuit to the generator is monitored.

INSTRUCTIONS FOR USE

- 1.. For maximum patient protection, routinely inspect the connectors, cord and plug for breaks, cracks in the insulation, corrosion or loose connections. If any of these conditions exist, the Cord should be replaced.
2. To assemble the E7001–1R Patient Return Electrode to the Cord, thread the connectors onto the lugs on the Patient Return Electrode. Tighten the connectors firmly.
3. Consult the Instructions for Use for the E7001–1R Patient Return Electrode for further precautions and recommendations for use of this patient return electrode system.
4. Care should be taken to firmly grasp and align the cord plug when inserting it or extracting it from the generator connection. Failure to do so will reduce the life of the Cord and will increase the incidence of REM™ alarms due to loose connections.

CLEANING/DECONTAMINATION

Cleaning and decontamination may be accomplished using any method selected by your institution for delicate surgical instruments.

STERILIZATION

The E0009–1R Cord may be sterilized by ethylene oxide gas (EtO) or steam autoclave using procedures approved by your institution. Do not exceed 275°F (135°C). Do not autoclave the E0009–1R unwrapped. Protect the E0009–1R from contact with other instruments during sterilization for longest product life.

Manufactured for Valleylab, Inc., Boulder, CO 80301 USA

E1001, E1002, E1003, E1004, E1005 Electrodes (items 10, 8, 9, 11, 12)

This product is supplied non-sterile.

Inspect the electrode insulation frequently (before and after each use) for cracks, nicks, cuts, dents or depressions which may decrease the insulation effectiveness.

The number of uses obtained from the electrode is highly dependent upon the method of sterilization selected, the care taken in processing and handling, and the surgical procedures and techniques in which the electrode is used.

Valleylab electrodes have a standard 3/32" (2,4mm) diameter shaft and are designed to fit Valleylab and most other electrosurgical pencils and chuckhandles. However, prior to each use, it is important to check the electrode connection to the accessory you are using to assure proper fit and compatibility.

CAUTION: Improper electrode installation may result in injury to the patient or operating room personnel by arcing at the electrode/pencil connection.

STERILIZATION

The electrodes may be sterilized by ethylene oxide gas (EtO) or steam autoclave using procedures approved by your institution. Do not exceed 275°F (135°C). Do not autoclave the electrodes unwrapped. Protect the electrodes from contact with other instruments during sterilization for longest product life.

INSTRUCTIONS FOR USE

1. Before inserting or changing an electrode, be sure the active accessory is not connected to an electrosurgical generator or that the generator is OFF (STANDBY).
2. Grasping the electrode by the insulating sleeve, insert the round shank into the electrosurgical accessory until the insulating sleeve is inserted approximately 1/8" (3,2mm). The shank and insulating sleeve should fit securely into the active accessory.
3. If the shank and/or insulating sleeve does not fit, or the insulation will not insert 1/8" (3,2mm), use of this electrode/accessory combination is not recommended.
4. Refer to the generator instruction manual for proper procedures for connecting the active accessory to the generator.

WARNING: Keep active accessories away from the patient when not in use. An Accessory Holster (Valleylab Catalog No. E2400) may be used to hold active accessories safely.

CLEANING/DECONTAMINATION

Remove blood, mucous and tissue from the electrode using a mild cleaning solution or blood dissolving detergent. Process these electrodes as you would any other delicate surgical instrument at your institution.

Manufactured for Valleylab, Inc., Boulder, CO 80301 USA

E4086 Forceps (item 13), E4087 Forceps (item 17)

This product is supplied non-sterile.

CARE AND STERILIZATION

Use the decontamination and sterilization procedures prescribed by your institution for delicate surgical instruments. The forceps may be sterilized by ethylene oxide gas (EtO) or steam autoclave using procedures approved by your institution. Do not exceed 275°F (135°C). Do not autoclave the forceps unwrapped. Protect the forceps from contact with other instruments during sterilization for longest product life. Allow forceps to dry thoroughly prior to use.

Inspect the forceps for contamination on the switch contact located between the tines before and after each use. Occasional polishing of the switch contact with steel wool may be required.

NOTE: Uninsulated forceps are intended ONLY for use in low power bipolar procedures.

SET-UP AND USE

NOTE: These forceps are intended for use only with the Valleylab E0018 Reusable Cord.

CAUTION: Good operating room practice suggests that connections of adapters and accessories to the electrosurgical generator be made only while the generator is OFF (STANDBY). FAILURE TO OBSERVE THIS PRECAUTION OR HANDLING OF THESE CONNECTIONS WHILE THE GENERATOR IS ACTIVATED MAY RESULT IN INJURY OR ELECTRICAL SHOCK TO THE PATIENT OR OPERATING ROOM PERSONNEL.

1. Attach the sterile Handswitching Bipolar Forceps Cord to the sterile forceps by aligning the slot on the cord receptacle with the slot on the forceps connector. Ensure that the cord receptacle is fully seated against the forceps connector.
2. Plug the connector on the cord into the MICROBIPOLAR receptacle on the electrosurgical generator.
3. At the lowest power setting, test the forceps by closing the switch contact to key the generator. If the generator does not activate, check that the cord connection at the forceps is tight (see step 3), and the connection to the generator is secure (see steps 2 and 4).
4. Do not activate the generator until the forceps have made contact with the patient.

WARNING: Keep active accessories away from the patient when not in use. An accessory holster (Valleylab Catalog No. E2400) may be used to hold active accessories safely.

REPAIR

Valleylab coagulation forceps are delicate surgical instruments. Inspect forceps for proper tip alignment prior to initial use. If damaged or misaligned during shipping, Valleylab will replace the forceps. Valleylab is not responsible for tip alignment after initial use.

Repair of this product may be necessary after repeated use. Contact the Valleylab Service Dept., or mail the forceps to: Valleylab, Inc., Service/Forceps Repair, 5920 Longbow Drive, P.O. Box 9015, Boulder, CO 80301 USA

Please include your institution's purchase order number and specify "repair or replace" as well as the number of forceps returned.

WARRANTY

Valleylab, Inc. warrants its forceps to be free from defects in material and workmanship under normal use and service. Valleylab's obligation under this warranty is limited to the repair or replacement, at its sole option, of forceps which have been returned to it or its Distributor within one year after shipment of the product to the original purchaser, and which examination discloses, to Valleylab's satisfaction that the product is defective and was not the subject of misuse.

THIS WARRANTY IS IN LIEU OF ALL OTHER WARRANTIES, EXPRESS OR IMPLIED, INCLUDING THE WARRANTIES OF MERCHANTABILITY AND FITNESS, AND OF ALL OTHER OBLIGATIONS OR LIABILITIES ON THE PART OF VALLEYLAB.

E0018 Cord (item 17)

This product is supplied non-sterile.

NOTE: This Cord is intended for use with the Valleylab E4086 Forceps (item 13) and E4087 (item 17).

STERILIZATION

The E0018 Cord may be sterilized by ethylene oxide gas (EtO) or steam autoclave using procedures approved by your institution. Do not exceed 275°F (135°C). Do not autoclave the Cord unwrapped. Protect the Cord from contact with other instruments during sterilization for longest product life.

INSTRUCTIONS FOR USE

1. Attach the sterile Cord to the sterile forceps by aligning the slot on the Cord receptacle with the slot on the forceps connector. Ensure that the Cord receptacle is fully seated against the forceps connector.
2. Refer to the generator instruction manual for proper procedures to connect the forceps Cord to the generator.
3. Always disconnect the Cord from the forceps or generator by the connector. Do not pull on the cable. Improper disconnection may damage the Cord.

NOTE: A common cause of non-functioning handswitching bipolar forceps is a reusable Cord with poor continuity between the forceps and the electro-surgical generator. A worn out or damaged Cord cannot be repaired. For maximum protection, routinely inspect the Cord for breaks, cracks in the insulation, corrosion or loose connections. If any of these conditions exist, the Cord should be replaced.

Manufactured for Valleylab, Inc., Boulder, CO 80301, USA
Made in Taiwan

E7506 Patient Return Electrode (item 14)

INSTRUCTIONS FOR USE

1. Shave, clean and dry application site as needed.
2. Take the PolyHesive® Patient Return Electrode from the pouch and remove the backing paper.
3. Lightly touch the surface of the PolyHesive® gel to assure that the conductive adhesive is moist.
4. Pull the PolyHesive® electrode taut and apply it to the patient on the bias for better adhesion.
5. Apply finger pressure to adhesive border and massage entire electrode area to ensure adequate contact with patient's skin.
6. Following the surgical procedure, remove electrode slowly to avoid skin trauma.

SUGGESTED PLACEMENT AREAS

1. Select a well-vascularized, convex area in close proximity to the surgical site for electrode application.
2. Avoid scar tissue, bony prominences, adipose tissue and areas where fluid may pool.

CAUTIONS

1. Do not use electrode if package seal is broken or conductive adhesive has become dry.
2. Do not attempt to relocate the return electrode after initial application.
3. Electrode gel is not required and should not be used.
4. PolyHesive® patient return electrode is a single use item. Do not reuse.

NOTE: Use of this patient return electrode does not enable the REM™ Contact Quality Monitoring System to monitor impedance at the return electrode site. Only the continuity of the Patient Return Electrode circuit to the generator is monitored.

E2515 Disposable Handswitching Pencil (item 15)

Instructions For Use

1. Open package by peeling apart at the arrow indicated on the lid.
2. Remove the pencil from the package using aseptic technique.
3. Prior to use, check that the electrode is securely seated in the pencil. The blade electrode (supplied) is designed to lock in place to prevent rotation. To change the electrode orientation, grasp the electrode by the insulating sleeve, pull the electrode out of the pencil, rotate, and re-insert it into the pencil. The pencil will also accept standard 3/32" (2,4mm) diameter non-locking electrodes. Remove the tip protector from the electrode.

CAUTION: Improper electrode installation may result in injury to the patient or operating room personnel by arcing at the electrode/pencil connection.

4. Refer to the electrosurgical generator instruction manual for proper procedures to connect the pencil connector to the generator
5. When changing the electrode, be sure that the pencil is not connected to the generator, or that the generator is OFF (STANDBY).
6. Discard after use. The Disposable Handswitching Pencil is not designed to withstand resterilization. SINGLE USE ONLY – DO NOT RESTERILIZE.

WARNING: Keep active accessories away from the patient when not in use. An accessory holster (Valleylab Catalog No. E2400) may be used to hold active accessories safely.

E2003 Reusable Chuckhandle (item 16)

This product is supplied non-sterile.

STERILIZATION

The E2003 Surgical Handle (Chuckhandle) may be sterilized by ethylene oxide gas (EtO) or steam autoclave using procedures approved by your institution. Do not exceed 275°F (135°C). Do not autoclave the E2003 unwrapped. Protect the E2003 from contact with other instruments during sterilization for longest product life.

INSTRUCTIONS FOR USE

1. Inspect the Chuckhandle body and cord prior to each use. Chuckhandles which are nicked, cracked or damaged should be discarded.
2. The Chuckhandle accepts Valleylab and other standard 3/32" (2,4mm) diameter electrodes. Prior to each use, it is important to check the electrode connection to the Chuckhandle to assure proper fit and compatibility.
3. Before inserting or changing an electrode, be sure the Chuckhandle is not connected to an electrosurgical generator or that the generator is OFF (STANDBY).
4. Twist the retaining cap on the end of the Chuckhandle one turn counterclockwise to loosen the chuck.
5. Grasping the electrode by the insulating sleeve, insert the round shank into the Chuckhandle until the insulating sleeve is inserted approximately 1/8" (3,2mm). The shank and insulating sleeve should fit securely.
6. Twist the cap clockwise until snug to retain the electrode.
7. If the shank or insulating sleeve of the electrode does not fit or the insulation will not insert 1/8" (3,2mm), use of this electrode is not recommended.

CAUTION: Improper electrode installation may result in injury to the patient or operating room personnel by arcing at the electrode/pencil connection.

8. Refer to the generator instruction manual for proper procedures for connecting the Chuckhandle to the electrosurgical generator. This Chuckhandle is footswitch activated.

WARNING: Keep active accessories away from the patient when not in use. An accessory holster (Valleylab Catalog No. E2400) may be used to hold active accessories safely.

CLEANING/DECONTAMINATION

Decontamination may be accomplished using any method selected by your institution for delicate surgical instruments. The Chuckhandle may be disassembled for thorough cleaning.

Manufactured for Valleylab, Inc., Boulder, CO 80301 USA

